

From ASSEMBLY To SERVICING
HOZAN

catalog of tools
for electronics

2018





Precision diagonal cutters & Pliers

N-55
PRECISION DIAGONAL CUTTER
精密剪钳

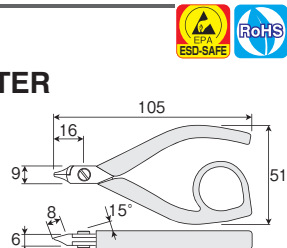

Part no. 型号	Cutting capacity 切断能力		Hardness HRC 硬度		Weight g 重量
	Copper wire mmφ 铜线	Copper stranded wire mm ² 铜绞线	Body 主体	Blade 刃部	
N-55	1.0	0.9	46	58	40
N-57	1.0	0.9	46	60	40
N-58	0.18 to 0.8 ^{※1}	0.9	46	60	40
P-51	—	—	46	—	42

※1 effective nose stop range 有效范围为导线制动器

N-57
PRECISION DIAGONAL CUTTER
精密剪钳

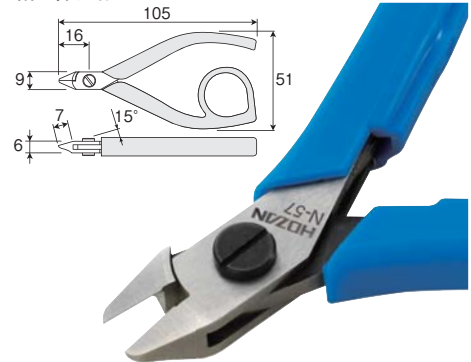
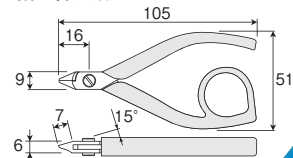

N-58
PRECISION DIAGONAL CUTTER
精密剪钳

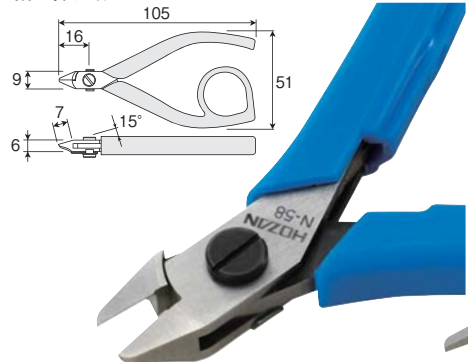
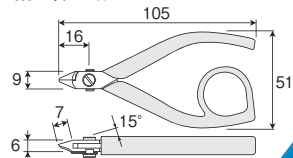

P-51
PRECISION PLIERS
精密剪钳

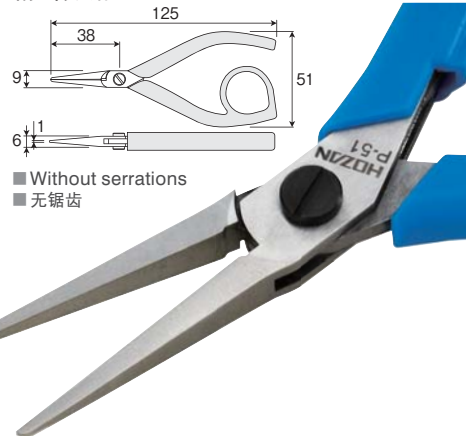
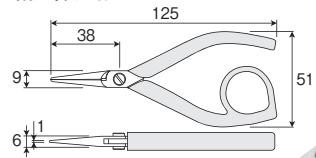

■ Without serrations
■ 无锯齿



Miniature diagonal cutter

N-31
MINIATURE DIAGONAL CUTTER
小型斜口剪钳

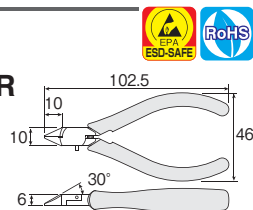

Part no. 型号	Cutting capacity 切断能力		Hardness HRC 硬度	Weight g 重量
	Copper wire mmφ 铜线	Copper stranded wire mm ² 铜绞线		
N-31	1.6	1.25	57	40
N-34	1.0	1.25	57	40
N-32	2.0	2	57	65
N-35	1.6	2	57	65

N-34
MINIATURE DIAGONAL CUTTER
小型斜口剪钳

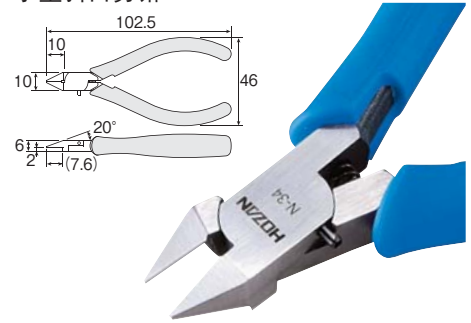
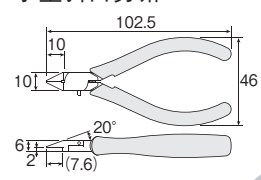

N-32
MINIATURE DIAGONAL CUTTER
小型斜口剪钳

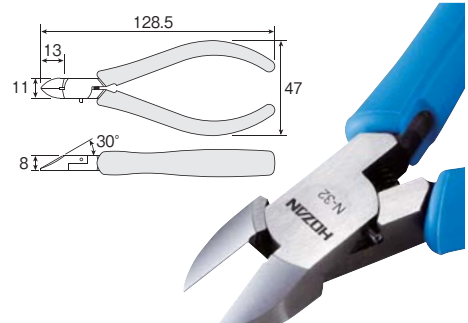
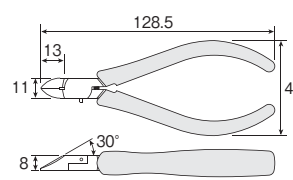

N-35
MINIATURE DIAGONAL CUTTER
小型斜口剪钳

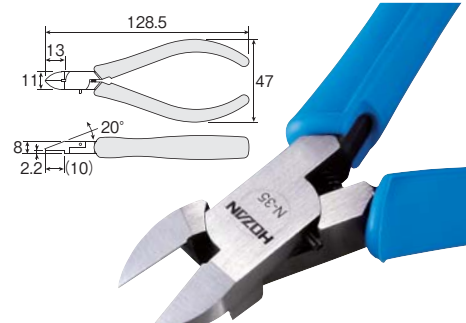
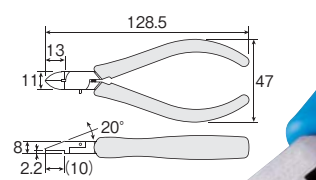

N-25-125/150
PLASTIC CUTTER
细塑料剪钳

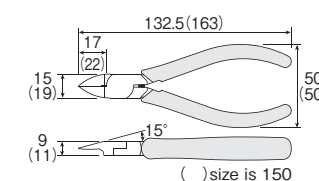

Part no. 型号	Cutting capacity 切断能力			Hardness HRC (blade) 硬度HRC (刃部)	Weight g 重量
	Copper wire mmφ 铜线	Copper stranded wire mm ² 铜绞线	Plastic mmφ 塑料		
N-25-125	—	—	5.0	52	90
N-25-150	—	—	5.0	52	150
N-36	1.0	0.9	1.5	56	58
N-33	1.0	0.9	—	57	45

N-36
MINIATURE END CUTTER
弯头剪钳

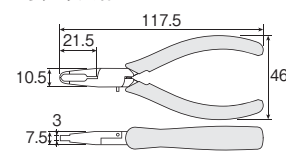

N-33
MINIATURE END CUTTER
弯头剪钳

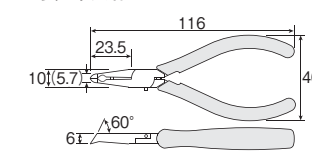

N-23
DIAGONAL CUTTER
剪钳

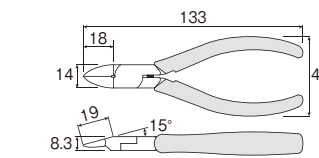

Part no. 型号	Cutting capacity 切断能力			Stripping hole mmφ 带剥线孔	Hardness HRC (blade) 硬度HRC (刃部)	Weight g 重量
	Steel wire mmφ 铁线	Copper wire mmφ 铜线	Copper stranded wire mm ² 铜绞线			
N-23	—	1.6	2	—	56	85
N-9-125	1.6	2.6	2	1.2	59	105
N-9-150	1.9	3.2	3.5	1.2/1.6	59	140
N-12	1.9	3.2	3.5	—	60	160
N-4-125	1.2	2.0	2	—	58	95
N-4-150	1.4	2.6	2	—	58	140
N-5-125	1.2	2.0	2	1.2	58	95
N-5-150	1.4	2.6	3.5	1.2/1.6	58	140

N-9-125/150
DIAGONAL CUTTER WITH STRIPPER
剪钳(带剥线孔)

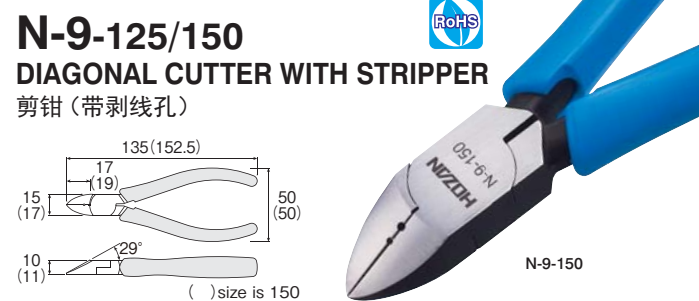
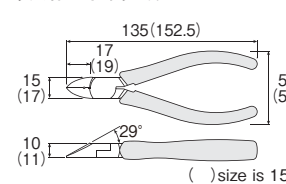

N-12
DIAGONAL CUTTER
剪钳

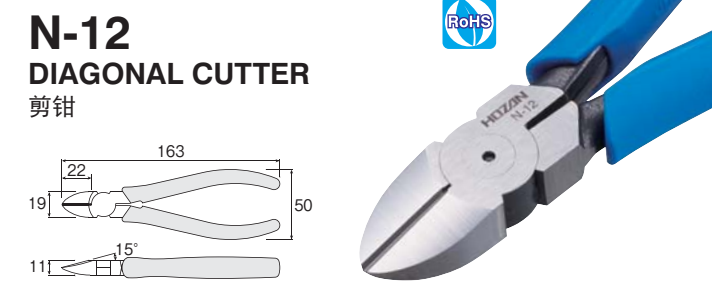
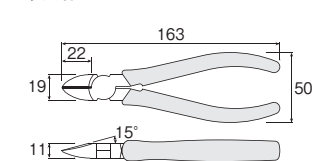

N-4-125/150
DIAGONAL CUTTER
斜口剪钳

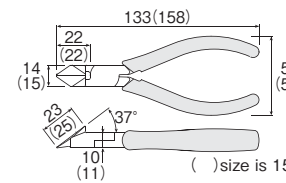

N-5-125/150
DIAGONAL CUTTER WITH STRIPPER
斜口剪钳(带剥线孔)

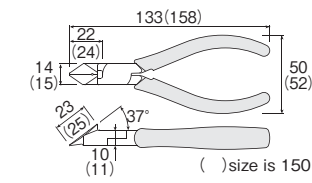

Snips



N-838
SNIPS
强力型剪刀

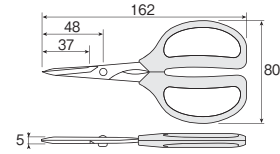

Part no. 型号	Cutting capacity 切断能力					Hardness HRC (blade) 硬度HRC (刃部)	Weight g 重量
	Copper stranded wire mm ² 电线	Aluminum plate mm 铝合板	Coaxial cable 同轴电缆	Steel wire mmφ 铁线	VVR wire mm ² VVR线		
N-838	2	0.5	-	-	-	59	58
N-841	2	0.7	5C-2V	0.3 (Non heat treatment) (无热处理)	-	59	60
N-839	8	1.2	-	-	3.5 × 3 conductors 芯	3.5 × 4 conductors 芯	58 150

N-841
SNIPS
强力型剪刀

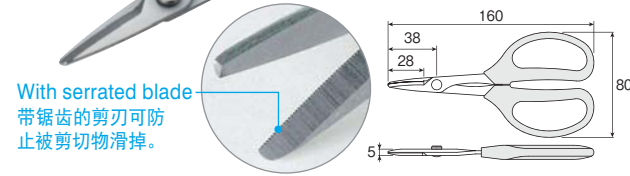

With serrated blade
带锯齿的剪刀可防止被剪切物滑掉。

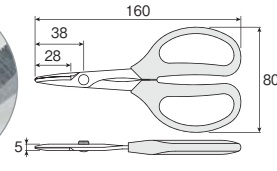

N-839
SNIPS
多用途剪刀

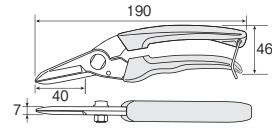
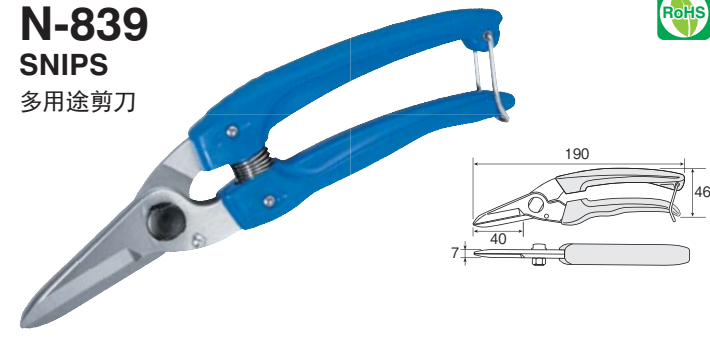

N-18
CABLE CUTTER
电缆钳

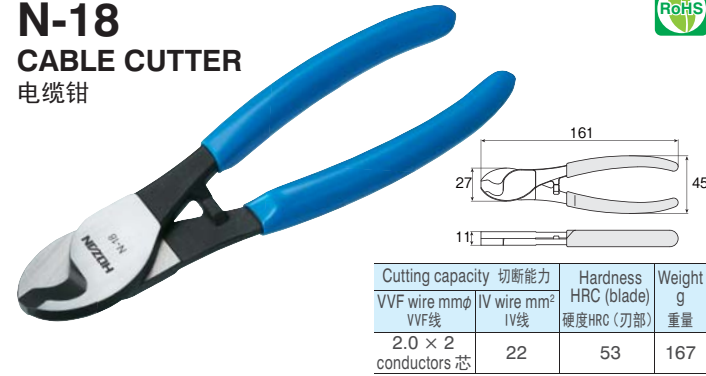

Cutting capacity 切断能力		Hardness HRC (blade) 硬度HRC (刃部)	Weight g 重量
VVF wire mmφ VVF线	IV wire mm ² IV线		
2.0 × 2 conductors 芯	22	53	167

Miniature long nose pliers



N-16
WIRE CUTTER
钢丝钳

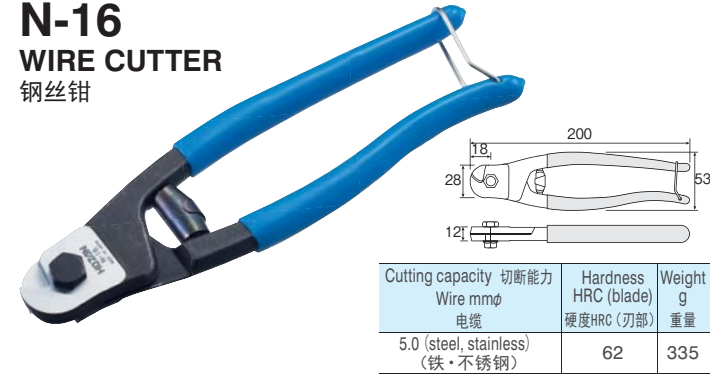

Cutting capacity 切断能力		Hardness HRC (blade) 硬度HRC (刃部)	Weight g 重量
Wire mmφ 电缆	电缆		
5.0 (steel, stainless) (铁·不锈钢)		62	335

P-36
MINIATURE LONG NOSE PLIERS
小型尖嘴钳

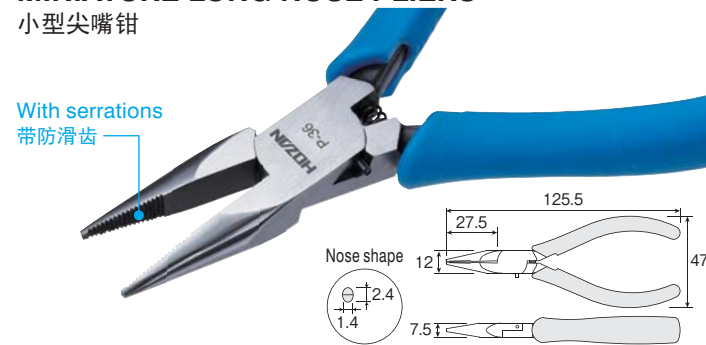

With serrations
带防滑齿

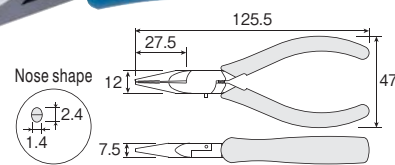

P-35
MINIATURE LONG NOSE PLIERS
小型尖嘴钳



Part no. 型号	Hardness HRC 硬度	Weight g 重量
P-35	42	45
P-36	46	65
P-37	46	60

P-37
MINIATURE LONG NOSE PLIERS
小型尖嘴钳

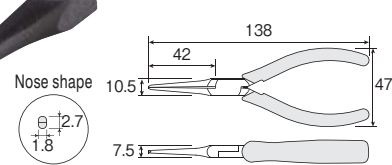

With serrations
附带防滑锯齿

P-34
MINIATURE FLAT NOSE PLIERS
小型扁嘴钳

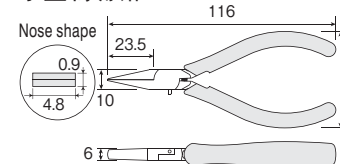
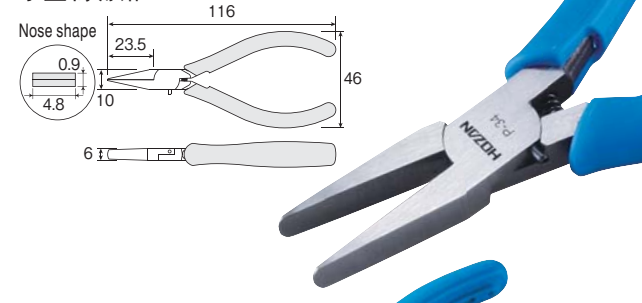

With serrated gripping hole
(150 mm only)
附带孔型锯齿 (只有150mm)

With serrations
附带防滑锯齿

P-15-125/150
LONG NOSE PLIERS WITH SIDE CUTTER
尖头钳

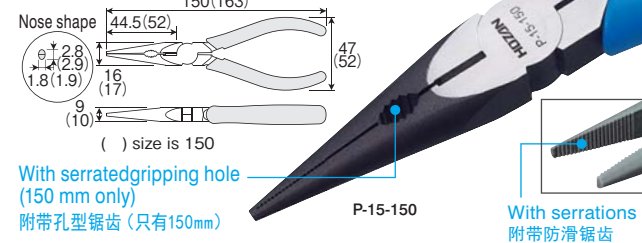

With serrated gripping hole
(150 mm only)
附带孔型锯齿 (只有150mm)

With serrations
附带防滑锯齿

P-16
MINIATURE ROUND NOSE PLIERS
平嘴尖头钳

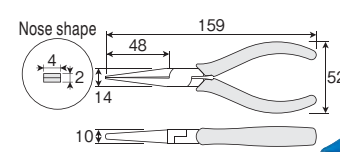
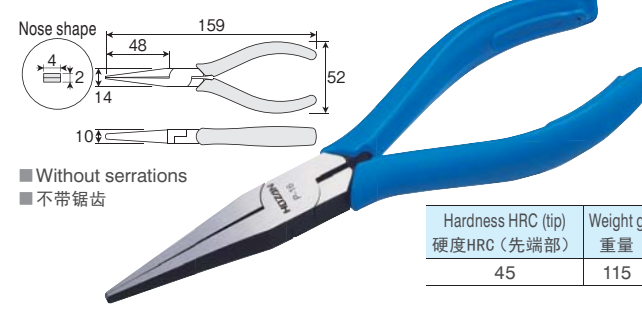

Without serrations
不带锯齿

Hardness HRC (tip) 硬度HRC (先端部)	Weight g 重量
45	115

P-33
MINIATURE PLIERS
小型钳子



Part no. 型号	Hardness HRC 硬度	Weight g 重量
P-33	42	56
P-34	42	40
P-39	46	58

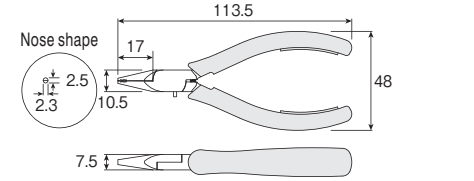

P-39
MINIATURE ROUND NOSE PLIERS
小型圆夹钳

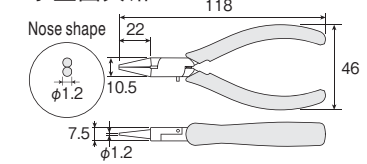
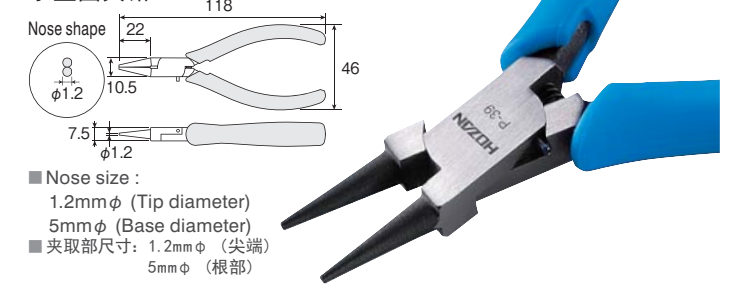

Nose size :
1.2mmφ (Tip diameter)
5mmφ (Base diameter)
夹取部尺寸: 1.2mmφ (尖端)
5mmφ (根部)

P-14-125/150
LONG NOSE PLIERS WITH SIDE CUTTER
尖头钳



Part no. 商品号	Cutting capacity 切断能力		Hardness HRC (blade) 硬度HRC (刃部)	Weight g 重量
	Copper wire mmφ 铜线	Copper stranded wire mm ² 铜绞线		
P-14-125				100
P-14-150				125
P-15-125	2.6	2	58	100
P-15-150				125
P-22				125

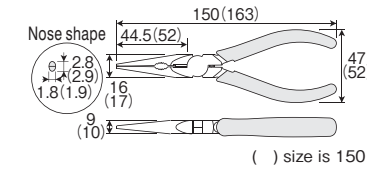

() size is 150

P-22
LONG NOSE PLIERS WITH SIDE CUTTER
尖头钳

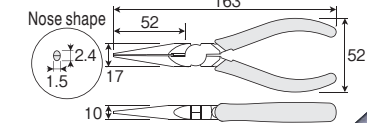
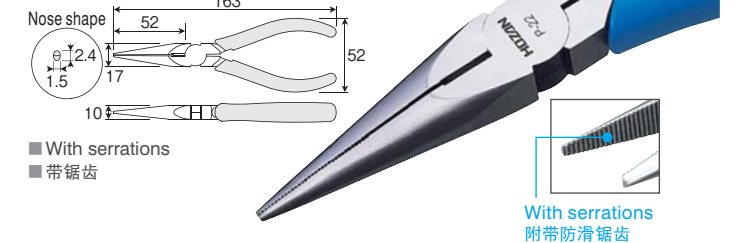

With serrations
带锯齿

With serrations
附带防滑锯齿

P-12
MINIATURE ROUND NOSE PLIERS
弯嘴尖头钳

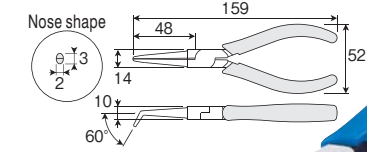

Without serrations
不带锯齿

Hardness HRC (tip) 硬度HRC (先端部)	Weight g 重量
45	115

Lineman's Pliers



P-59-175
LINEMAN'S PLIERS
钢丝钳

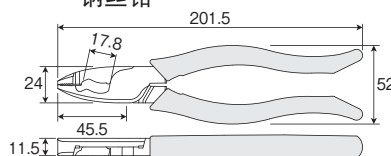

P-57-175/200
LINEMAN'S PLIERS
钢丝钳

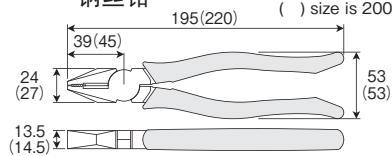

P-43-150/175
LINEMAN'S PLIERS
钢丝钳

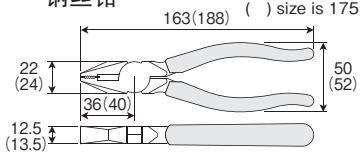

Part no. 商品号	Cutting capacity 切断能力			Hardness HRC 硬度		Weight g 重量
	Copper wire mmφ 铜线	Copper stranded wire mm² 铜绞线	VVF mmφ VVF线	Tip 先端部	Blade 刃部	
P-59-175	2.6	5	2.0 × 3 wires 芯	58	—	245
P-57-175	3.5	5.5	1.6 × 3 wires 芯	—	61	270
P-57-200	4.0	5.5	2.0 × 3 wires 芯	—	61	370
P-43-150	3.3	3.5	1.6 × 2 wires 芯	—	60	210
P-43-175	3.5	5.5	1.6 × 2 wires 芯	—	60	288

Chain Pliers



P-221
CHAIN PLIERS
链条钳

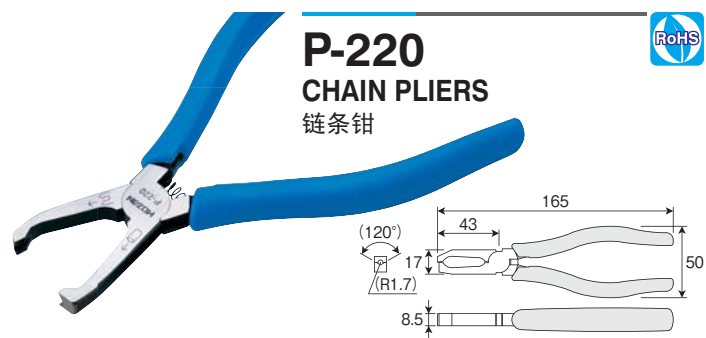

P-220
CHAIN PLIERS
链条钳

Part no. 商品号	Compatible chains 适用链条	Working chain size 适用范围			Weight g 重量
		For industrial machinery 主要用于工业机械	For bicycles 自行车用	For motorcycles 自主用于摩托车	
P-221	Roller chains (clip types)	35 to 60	1/2 × 1/8	410 to 630	150
P-220	滚子链 (弹簧夹子形)	35 to 50		410 to 530	

Pliers

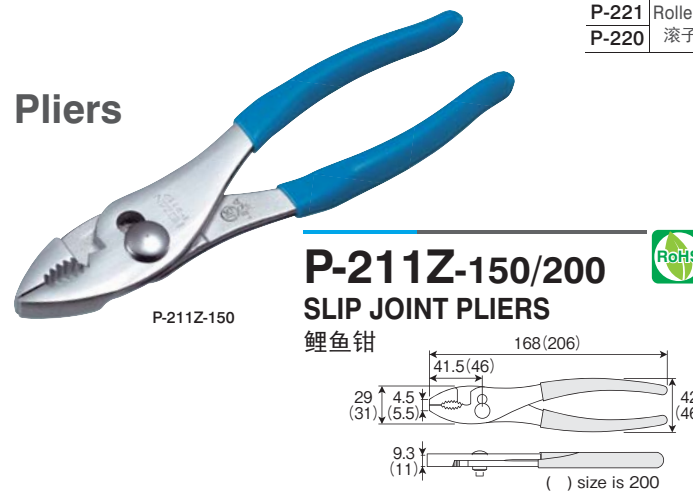

P-211Z-150/200
SLIP JOINT PLIERS
鲤鱼钳

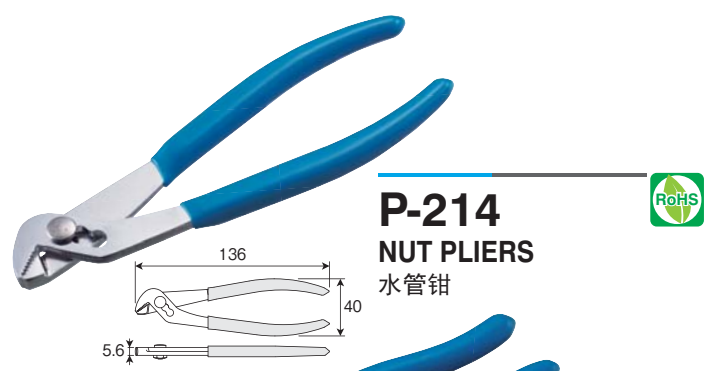

P-214
NUT PLIERS
水管钳



P-245
WATER PUMP PLIERS
水管钳

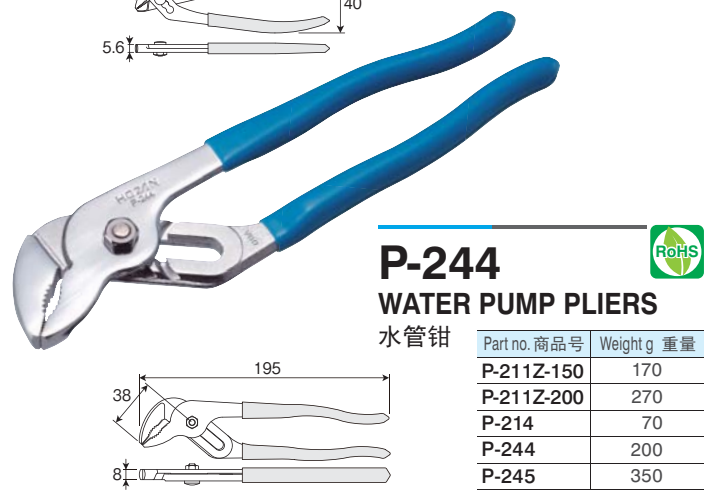

P-244
WATER PUMP PLIERS
水管钳

Part no. 商品号	Weight g 重量
P-211Z-150	170
P-211Z-200	270
P-214	70
P-244	200
P-245	350

WIRE STRIPPERS 剥线钳

For metric sizes

For AWG sizes



P-970
For metric-sizes



P-977
For fine wires
细线用

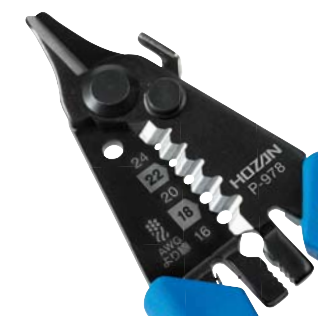

P-978
For medium-to-thick wires
中太線用



P-960
For metric-sizes



P-963
For very fine wires
Suitable for optical fibers
极细线用适用于光纤



P-967
For fine wires
细线用



P-968
For medium-to-thick wires
中太線用

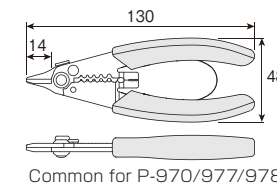

Common for P-970/977/978

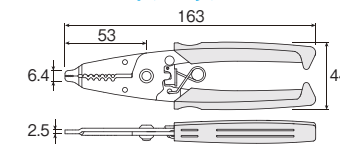

Common for P-960/963/967/968

Strippers compatibility table 剥线钳适用表

● For metric-sizes 适用于超细线

Single wire (mm) 单线	0.65	0.8	1.0	1.6	2.0
Stranded wire (mm) 绞线	0.3	0.5	0.75	1.25	2.0
P-970					
P-960					

※1 P-963 is also equipped with 0.25 mmφ and 0.45 mmφ sizes.
※1 P-963有其他的0.25mmφ、0.45mmφ尺寸的带孔型号。

● For AWG sizes AWG线径电线用

AWG	Single wire 单线	34	32	30	28	26	24	22	20	18	16	14	12
Stranded wire 绞线	—	34	32	30	28	26	24	22	20	18	16	14	12
Single wire (mm) 单线	0.14	0.20	0.25	0.32	0.40	0.51	0.64	0.81	1.02	1.29	1.63	2.05	
Stranded wire (mm) 绞线	0.014	0.023	0.035	0.055	0.089	0.14	0.22	0.34	0.53	0.87	1.38	2.18	
P-977													
P-978													
P-963			#1										
P-967													
P-968													

P-90-A/B/C/F
WIRE STRIPPERS

With adjustable stop.
Stripping length can be set within a 4 to 25 mm range.

剥线钳

付带剥线量尺。

可设定4~25mm的剥线长度。

Compatible wire size table 适用电线尺寸表

		AWG No.											
		24	22	20	18	16	14	12	10	8			
Min. single wire outer dia. (mm) 单股线最小外径		0.51	0.51	0.51	0.51	0.51	0.51	0.51	0.51	0.51	0.51	0.51	
Stranded wire min. cross-sectional area mm² 绞线最小截面积		0.20	0.20	0.20	0.20	0.20	0.20	0.20	0.20	0.20	0.20	0.20	
Stranded wire outer dia. mm ※1 绞线外径		0.6	0.69	0.9	1.07	1.2	1.2~1.35	1.6	1.8	1.95	2.4	2.6	
		0.7	0.75	0.98	1.15	1.4	1.26	1.47	1.8	1.86	2.0	2.5	
P-90-A	Hole indications 对应表格												
P-90-B	Single wire 单线		1.2	1.6									
	Stranded wire 绞线				1.0	1.6							
P-90-C	Single wire 单线					0.9	0.9	1.25	1.25	2.0	2.0	3.5	
	Stranded wire 绞线					0.9	0.9	1.25	1.25	2.0	2.0	3.5	
P-90-F	VCTFK wire (also usable for jacket) 对应内外被覆包装					0.75/1.25	0.75/1.25						
	Stranded wire 绞线												

※1: The stranded wire outer dia. 绞线由软皮线构成的外径由厂商决定, 多少会有差异。
※2: The plain wire structure vary somewhat according to the manufacturer. 由厂商而定, 不适用的场合也会出现。

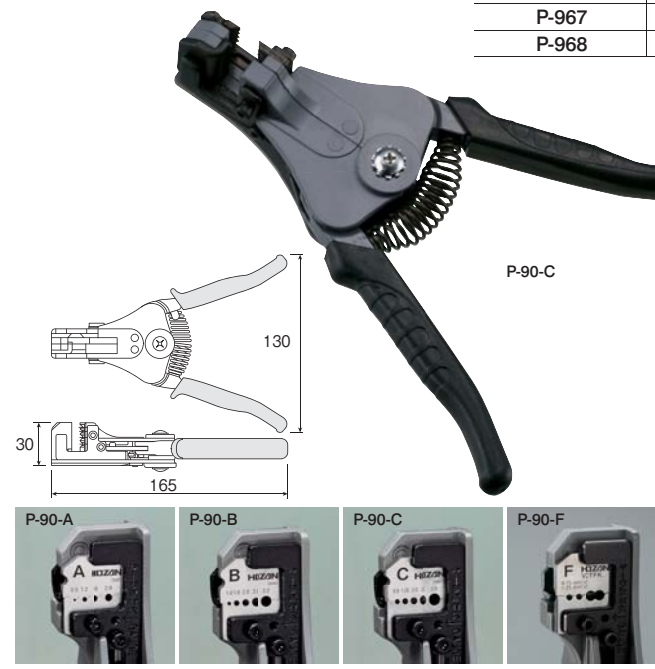



For uninsulated terminals and connectors (B / P)
裸压接端子·裸压接套筒 (B·P) 用



Leaves a crimp mark on the terminal.
压接完成后, 在压接端子上会被印上压接口尺寸。

P-726
CRIMPING TOOL
压接钳

Part no. 商品号	Sizes 适用尺寸	Crimp marking 压接后的标记	Weight g 重量
P-726	0.3/0.5/1.25/2	0/1/2	290
P-732	1.25/2	0/1	270
P-722	1.25/2	0/1	275
P-75	1.25/2/5.5/8	1/2/5/8	390



P-732
CRIMPING TOOL
压接钳

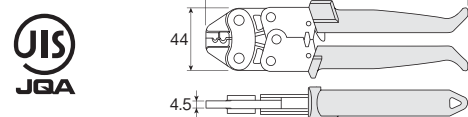

P-722
CRIMPING TOOL
压接钳

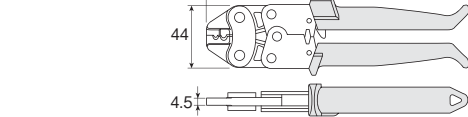

P-75
CRIMPING TOOL
压接钳

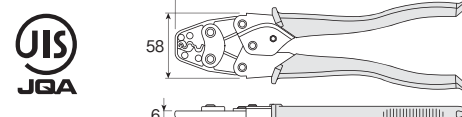

For insulated terminals and connectors
绝缘被覆带压接端子用



Leaves a crimp mark on the terminal.
压接完成后, 在压接端子上会被印上压接口尺寸。

P-743
CRIMPING TOOL

The handle opening width is adjustable to be used in small width.
压接钳
依据调整手柄张开的机构即使张开幅度很小也能作业。



Nominal sizes 名称	Connector manufacturer 适用端子厂商	Compatible wire sizes (reference) 适用电线尺寸 (参考)		Crimp marking 压接后的标记	Weight g 重量
		AWG#	mm ²		
0.5※	JST Fuji Terminal Industry 日本压接端子製造 富士端子工業	24 to 22	0.2 to 0.3	●	365
0.3/0.5※	Common to all manufacturers 各社通用	24 to 20	0.2 to 0.5	●●	
1.25		20 to 16	0.5 to 1.65	1	
2		16 to 14	1.04 to 2.63	2	

※ For JST and Fuji Terminal Industry brand "noted terminals" with a nominal size of 0.5, and a wire size of 0.2 to 0.3 mm², the appropriate die must be selected according to the wire type.
※ 日本压接端子製造、富士端子工業の場合の注意点端子的称呼为0.5、电线尺寸为0.2~0.3mm²的情况下请根据电线的种类选择尺寸。



For uninsulated terminals and connectors & insulated terminals and connectors
裸压接端子·绝缘压接端子用 (简易型)



P-704
CRIMPING TOOL
压接钳

Screw cutter mm 螺钉剪切	Wire stripper mm ² 剥线器	Sizes 适用尺寸	Weight g 重量
3 / 3.5 / 4	0.3 / 0.5 / 0.75 / 1.25 / 2	1.25 / 2 / CE1 / CE2	210

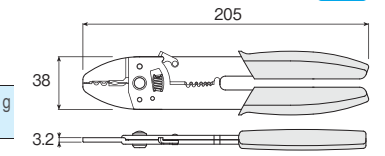

For insulated closed end terminals 绝缘闭端子用



Leaves a crimp mark on the terminal.
压接完成后, 在压接端子上会被印上压接口尺寸。

P-736
CRIMPING TOOL

Sizes 适用尺寸	Crimp marking 压接后的标记	Weight g 重量
CE1 / CE2 / CE5	1 / 2 / 5	315

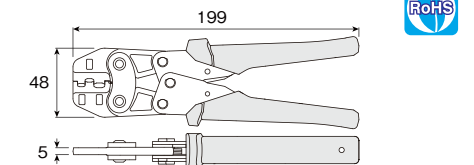

For open barrel terminals/contacts 开放型接线用



P-707
CRIMPING TOOL
压接钳

Wire sizes 适用电线尺寸	Weight g 重量
AWG#30 to #14	320

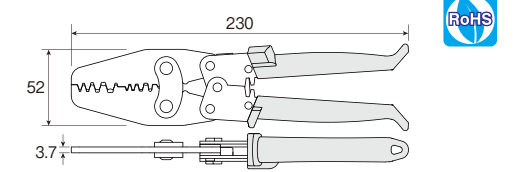

Nominal sizes 名称	Die width mm 宽度	Crimp height mm 卷曲	Compatible wire sizes 适用芯线 (参考) AWG# mm ²	Insulation OD mm 适用绝缘外径 (参考)
1.2	1.2	0.4	30 to 24 0.05 to 0.2	0.7 to 1.2
1.4L	1.4	0.55	30 to 20 0.05 to 0.5	0.9 to 1.5
1.7L	1.7	0.65	28 to 18 0.08 to 0.8	1.1 to 1.8
2.0L	2.0	0.8	26 to 16 0.13 to 1.25	1.3 to 2.2
2.4L	2.4	1.1	20 to 14 0.5 to 2.0	1.6 to 2.6
2.9L	2.9	1.5	18 to 14 0.8 to 2.0	1.9 to 3.2
	4.2	2.6		2.3 to 3.8
	φ1.6	1.5		1.0 to 1.6
	φ2.2	1.8		1.6 to 2.2



P-706
CRIMPING TOOL
压接钳

Wire sizes 适用电线尺寸	Weight g 重量
AWG#28 to #14	200

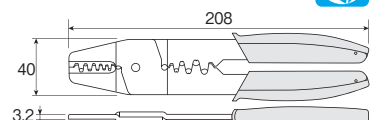

Nominal sizes 名称	Die width mm 宽度	Crimp height mm 卷曲	Compatible wire sizes 适用芯线 (参考) AWG# mm ²	Insulation OD mm 适用绝缘外径 (参考)
1.4	1.4	0.7	28~24 0.08~0.2	0.7~1.2
1.7L	1.7	1.1	28~22 0.08~0.3	0.9~1.5
1.7H	1.7	1.1	24~18 0.2~0.8	1.1~1.8
2.0L	2.0	0.9	28~18 0.08~0.8	1.1~1.8
2.0H	1.3	2.4~16	0.2~0.8	1.1~1.8
2.4L	1.2	20~16	0.5~1.25	1.3~2.2
2.4M	1.5	16~14	1.25~2.0	1.3~2.2
	2.4H	2.4		1.3~2.2
	2.8	2.8		1.6~2.6
	3.2	3.2		1.8~3.0
	3.7	3.7		2.1~3.5
	φ1.8	1.8		1.2~1.8
	φ2.5	2.5		1.8~2.5
	φ4.0	4.0		2.3~3.8

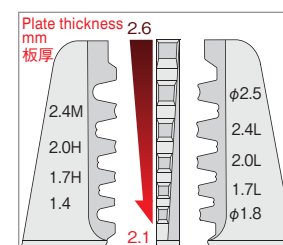
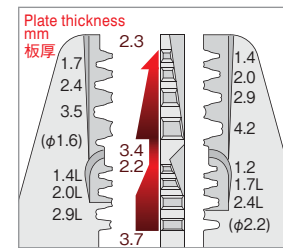

Tip is replaceable Tweezers
尖端可交换镊子

ESD TIP TWEEZERS
防静电尖端镊子



PLASTIC TIP TWEEZERS
塑料镊子



P-610-G
ELASTOMER TIP TWEEZERS
尖端柔软镊子



P-848
ESD TIP TWEEZERS
防静电尖端镊子



Part no. 型号	Tip width 尖端宽				Material 材質	Tip color 镊子头颜色	Heat resistant temp. (tip) 耐热温度 (镊子头)	ESD standard ESD管理值	Weight 重量
	A	B	C	D					
P-640-S					PEEK	Black 黑	315	Rg<1×10 ¹²	17
P-641-S	125	48							
P-642-S									
P-643-S	124	47							
P-644-S			10	10	Aluminum 铝				8
P-645-S									
P-650-S	125	48			PBT	White 白	220	-	17
P-640-P									
P-644-P									
P-610-G					POLYPROPYLENE + ELASTOMER 聚丙烯+弹性材料	White + gray 白+灰	100	-	17
P-848	125	49		9~40					

CERAMIC TWEEZERS
陶瓷镊子

P-646-D
ESD CERAMIC TIP TWEEZERS
防静电陶瓷镊子

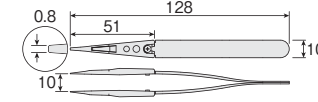

P-646-C
CERAMIC TIP TWEEZERS
陶瓷镊子

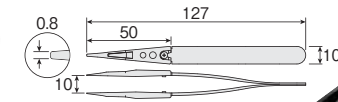

P-890
CERAMIC TWEEZERS
陶瓷镊子

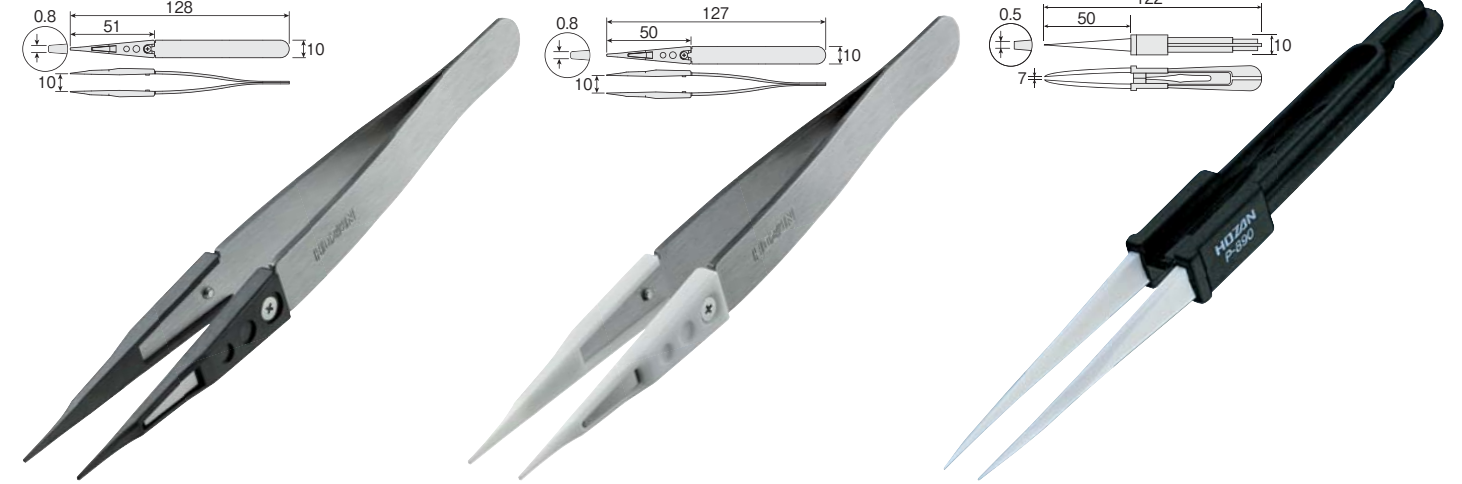
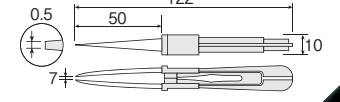

Part no. 型号	Tip width mm 先端幅	Material 材質		ESD standard ESD管理值	Weight g 重量	Heat resistant temp. (tip) °C 耐热温度 (镊子头)
		tip 镊子头	handle 本体			
P-646-D	0.8	Zirconia ceramic 陶瓷	Stainless 不锈钢	Rg<1×10 ¹²	22	1200
P-646-C	0.8	Zirconia ceramic 陶瓷	Polyacetal 塑料	-	8	700

Heavy-duty tweezers
強力型镊子

P-891
TWEEZERS
镊子

P-892
TWEEZERS
镊子

P-894
TWEEZERS
镊子



TWEEZERS
镊子

P-898
TWEEZERS
镊子

P-887
CURVED TWEEZERS
弯尖嘴镊子

P-895
TWEEZERS
镊子

P-899
TWEEZERS
镊子



Part no. 型号	Tip width 尖端宽				Sheet thickness 板厚	Material 材質	Weight 重量
	A	B	C	Tip width 尖端宽			
P-891					2.3	Stainless 不锈钢	23
P-892	125	9.5					
P-894				0.25	2.0	(SUS420J2)	17
P-898	110	10					
P-887	130			0.6	2.5		26
P-895	150	9.5					
P-899	110			0.5			25

TWEEZERS 镊子

Part no. 型号	Tip width 尖端宽 (mm)			Material 材質	Weight g 重量
	A	B	C		
PP-110	125			Stainless (SUS316L)	19
PP-111	115	10	8		
PP-112			0.3		
PP-114	140	9			

Short type with a total length less than 100 mm
短型, 总长度小于100毫米

P-653 P-654

TWEEZERS 镊子

Part no. 型号	Tip width 尖端宽 (mm)			Material 材質	Weight g 重量
	A	B	C		
P-653	70	7	6	Stainless (SUS316L)	7
P-654	90	7.5	0.2		

TWEEZERS 镊子

Part no. 型号	Tip width 尖端宽 (mm)			Material 材質	Weight g 重量
	A	B	C		
P-880	120			Stainless (SUS304)	19
P-881	110	10	7		
P-882	115				
P-886	125	12	10		

With serrations 防滑花纹

P-86-125/150/175 P-87

With serrations 防滑花纹

TWEEZERS 镊子

Part no. 型号	Tip width 尖端宽 (mm)			Material 材質	Weight g 重量
	A	B	C		
P-87	125	11	13	Stainless (SUS410)	16
P-86-125	130		18		
P-86-150		10	25		
P-86-175	175		30		

P-873 TWEEZERS 镊子

Ultra-thin tip 极细型

Tip size mm 尖端宽	Thickness 厚度	Material 材質	Weight g 重量
0.4	0.2	Stainless (SUS316L) 不锈钢	13

P-888 TWEEZERS 镊子

Spatula-shaped tips 平头

Tip size mm 尖端宽	Material 材質	Weight g 重量
2 (R-type) (R型)	Stainless (SSUS420J2) 不锈钢	15

P-878 TWEEZERS 镊子

Tip size mm 尖端宽	Thickness 厚度	Material 材質	Weight g 重量
4	2.2	Stainless (SUS304) 不锈钢	18

P-881-ESD P-891-ESD

Use this ESD soft grip on your standard tweezers to make them ESD safe.
防静电, 手柄柔软的镊子

Elastomer soft grip 橡胶制成的柔软的手柄

Protective cap 保护盖

Can be attached to the hook. (hole dia.: 5 mm φ) 可以挂起来(孔内径5mm φ)

ESD CUSHION GRIP TWEEZERS 防静电带套镊子

Part no. 型号	Material 材質		Weight g 重量	ESD standard Ω ESD管理值
	Grip / Cap 橡胶	Tweezers 镊子		
P-881-ESD	Elastomer 橡胶	Stainless (SUS304) 不锈钢	26	Rg<1×10 ¹²
P-891-ESD		Stainless (SUS420J2) 不锈钢	32	

() size is for P-891-ESD
() 尺寸是P-891-ESD

P-845 ESD CUSHION GRIP 带套镊子

Material 材質	Weight g 重量	ESD standard Ω ESD管理值
Elastomer 橡胶	9	Rg<1×10 ¹²

Usable tweezers size 可使用的镊子尺寸

* It may not be possible to attach the cap when using curved tweezers or tweezers longer than 130 mm, etc.
※需要130mm以上或尖端弯曲的特殊形状时, 保护盖会有盖不上的情况。
Simply insert and secure with adhesive tape! 插入后仅用胶布固定!

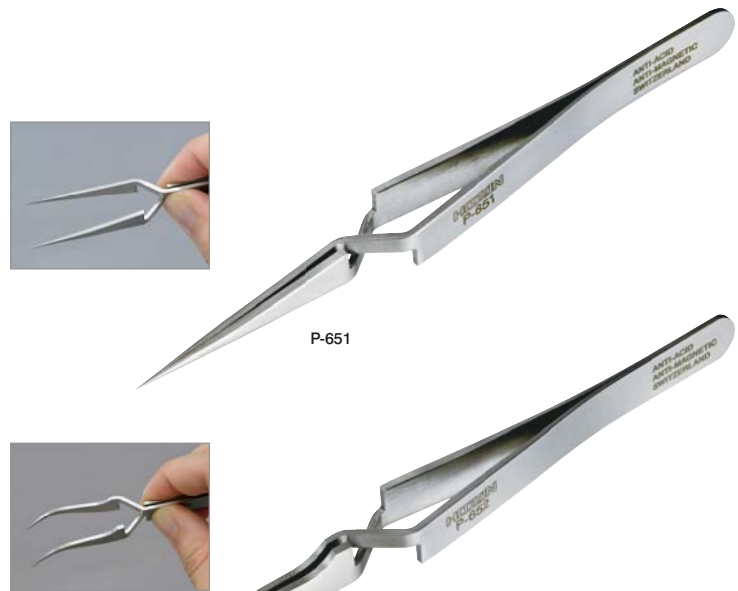

P-651/P-652
REVERSE ACTION TWEEZERS
反作用镊子



Part no. 型号	Tip width 尖端宽		A (mm)	B (mm)	Material 材质	Weight 重量
	Max. open width 最大开口宽	Tip width 尖端宽				
P-651	118	9.8	0.2	15	Stainless (SUS316L) 不锈钢	13
P-652	115	9.5				



P-89
REVERSE ACTION TWEEZERS
反作用镊子



OAL mm 全长	Tip width mm 前端宽	Max. open width mm 最大开口宽	Material 材质	Weight g 重量
165	2	approx. 20 约	Stainless (SUS304) 不锈钢	28

With slip-prevention serrations
防滑花纹



TITANIUM TWEEZERS
钛镊子



Part no. 型号	Tip width 前端宽			Material 材质	Weight g 重量
	A (mm)	B (mm)	C (mm)		
PP-120	125			64 Titanium alloy 64钛合金	13
PP-121	115	10	8		11
PP-122	140	9			12
PP-124					

P-860-125/150
BAMBOO TWEEZERS
竹镊子



Part no. 型号	Material 材质	Weight g 重量
P-860-125	Bamboo 竹	4
P-860-150	Bamboo 竹	5

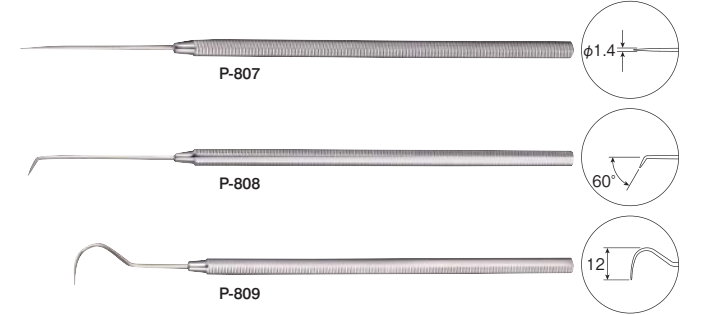

P-863-150
ESD BAMBOO TWEEZERS
防静电竹镊子



Material 材质	Weight g 重量	ESD standard ESD管理值
Bamboo 竹	5	Rg<1×10 ¹²



P-807~P-809
STAINLESS PROBE
不锈钢探针



Part no. 型号	A (mm)			Tip width mm 尖端宽	Material 材质	Weight g 重量
	B (mm)	C (mm)				
P-807	150	40	4.5	0.1	Stainless 不锈钢	14
P-808	140	38				
P-809	140	31				

P-806
BAMBOO PROBE
竹探针



Quantity 入数	Material 材质	Weight g 重量
2 pieces 2本	Bamboo 竹	5



P-843
FORCEPS
零部件固定夹

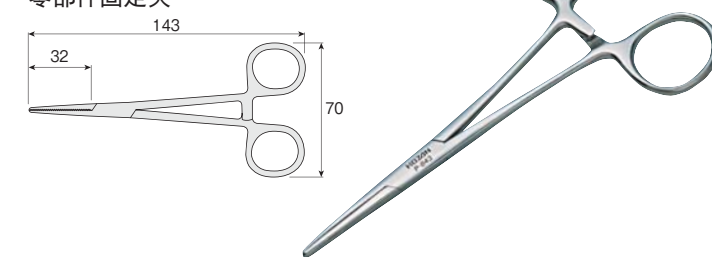

Material 材质	Weight g 重量
Stainless 不锈钢	30

With lock (3-step)
锁紧设计(3段式)

With serrations
防滑设计

Z-364
MAGNETIC PICKUP TOOL
笔式磁吸



OAL mm 全长	Magnet power mT 磁力	Magnet dia. mm 磁石径	Weight g 重量
140 (max. 630) 最大	120 (1200 Gauss)	19	45

P-64
SPRING HOOK
弹簧挂钩

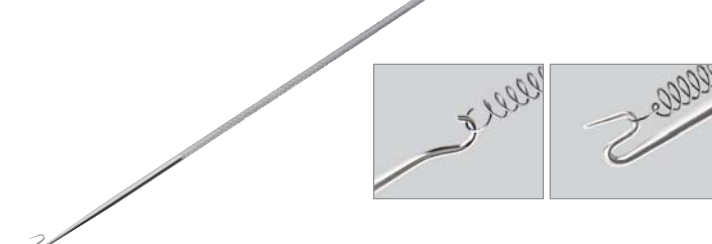

OAL mm 全长	Handle diameter mm 手柄直径	Material 材质	Weight g 重量
200	3	Stainless 不锈钢	9



D-530~D-555 ⊕
PHILLIPS SCREWDRIVER
十字螺丝刀

Part no. 型号	Tip size 前端尺寸	OAL mm 全长	Blade length mm 轴长	Blade diameter mmφ 轴径	Handle diameter mmφ 手柄直径	Weight g 重量
D-530-75	⊕No.00	124	75	3.0	15.4	9
D-540-100	⊕No.0	178	100	4.0	19.8	25
D-550-100	⊕No.1	200		5.0	30.0	57
D-555-100	⊕No.2	410	300	6.0	33.5	124
D-555-300						



D-630~D-655 ⊖
SLOTTED SCREWDRIVER
一字螺丝刀

Part no. 型号	Tip size mm 前端尺寸	OAL mm 全长	Blade length mm 轴长	Blade diameter mmφ 轴径	Handle diameter mmφ 手柄直径	Weight g 重量
D-630-75	⊖2.5×0.35	124	75	3.0	15.4	9
D-630-100	⊖4.0×0.45	149	100	3.0	15.4	10
D-640-100		4.0		19.8	25	
D-650-100	⊖5.0×0.7	200	200	5.0	30.0	57
D-655-100	⊖5.5×0.8					



D-331/D-332 ⊕⊖
ELECTRICIAN'S SLOTTED SCREWDRIVER
ELECTRICIAN'S PHILLIPS SCREWDRIVER
电工螺丝刀

Part no. 型号	Tip size mm 前端尺寸	OAL mm 全长	Blade length mm 轴长	Blade diameter mmφ 轴径	Handle diameter mmφ 手柄直径	Weight g 重量
D-331-100	⊖6.0×1.0	200	100	6.4	40	120
D-331-150		250	150			130
D-332-100	⊕No.2	200	100	6.4	40	120
D-332-150		250	150			130



D-52~D-58 ⊕⊖
REVERSIBLE SCREWDRIVER
可替换螺丝刀

Part no. 型号	Tip size mm 前端尺寸	OAL mm 全长	Blade length mm 轴长	Blade diameter mmφ 轴径	Handle diameter mmφ 手柄直径	Weight g 重量
D-52	⊕No.00/⊖2.5×0.4	181	57+57	3.0	29.5	40
D-54	⊕No.1/⊖4.0×0.55			5.0		53
D-58	⊕No.2/⊖5.5×0.9			6.0		63

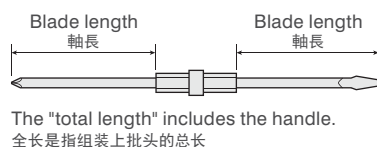

D-44 ⊕⊖
REVERSIBLE SCREWDRIVER SET
可替换螺丝刀

Set contents 配置明细	D-52/D-54/D-58
Weight 重量	161g



D-59 ⊕⊖
REVERSIBLE STUBBY SCREWDRIVER
可替换螺丝刀

Tip size mm 前端尺寸	OAL mm 全长	Blade length mm 轴长	Blade diameter mmφ 轴径	Handle diameter mmφ 手柄直径	Weight g 重量
⊕No.2/⊖6.0×0.8	89	17+17	6.0	35.5	45

D-68/D-69 ⊕⊖
STUBBY SCREWDRIVER
螺丝刀

Part no. 型号	Tip size mm 前端尺寸	OAL mm 全长	Blade length mm 轴长	Blade diameter mmφ 轴径	Handle diameter mmφ 手柄直径	Weight g 重量
D-68	⊖6.0×0.9	83	35	6.0	35.5	45
D-69	⊕No.2					



D-963 ⊕⊖
IMPACT SCREWDRIVER

A 12.7 mm square (1/2" sq) socket can be attached by removing the tip holder.
Left/right selectable rotation.

冲击螺丝刀
取出螺丝刀头的话,可以安装12.7mm角(1/2sp)的插口。
左右转动转换式。



Accessory bits 标配批头	⊕No.2/⊕No.3/⊕No.4/⊖10mm (total length: 36 mm) (全长36mm) ⊕No.2/⊕No.3 (total length: 80 mm) (全长80mm)
Bit width-across-flats 批头对连连	8mm
Handle diameter 手柄直径	37.5mm φ
Weight 重量	880g

■ With case
■ 带工具箱



D-745 LR41
LED VOLTAGE CHECKER
LED测电笔

Voltage range V 适应范围	Tip size mm 先端尺寸	OAL mm 全长	Blade length mm 轴长	Blade diameter mmφ 轴径	Handle diameter mmφ 手柄直径	Weight g 重量
AC100~240	⊖2.5×0.6	139	17	2.5	16	23

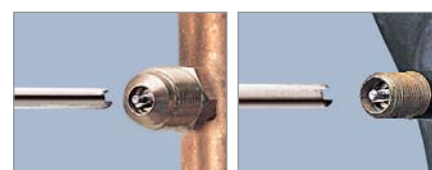

Device valve for piping
配管用機器閥



USA type tamper-proof
美式气管閥

D-13
VALVE CORE SCREWDRIVER

A dedicated valve core screwdriver for Schrader valves (for tire tubes).

真空用螺丝刀
用于美式真空(内胎用)的里面装拆的便利的螺丝刀
把手是能够快速旋转的六角形状

Handle diameter 手柄直径	10.0mm φ
Weight 重量	8g



D-20 **PRECISION SCREWDRIVER SET**
精密螺丝刀组

Set contents 配置明细	Pouch dimensions mm 工具包尺寸	Weight g 重量
D-20-11/D-20-12/D-20-14/ D-20-15/D-20-16/D-20-17	100 (W) × 117 (H) × 10(D) mm	90

PRECISION SCREWDRIVER
精密螺丝刀

Part no. 型号	Tip size mm 前端尺寸	OAL mm 全长	Blade diameter mmφ 轴径	Handle diameter mmφ 手柄直径
D-20-11	⊕ No.0	102	2.3	5.5
D-20-12	⊕ No.1	110	3.0	6.0
D-20-14	⊖ 1.2×0.32	83	1.2	3.9
D-20-15	⊖ 1.8×0.32	95	1.8	4.5
D-20-16	⊖ 2.3×0.35	102	2.3	5.5
D-20-17	⊖ 3.0×0.45	110	3.0	6.0

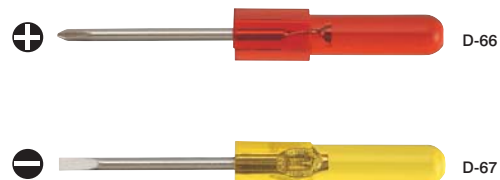

D-66/D-67 **MICRO SCREWDRIVER**
微型螺丝刀

Part no. 型号	Tip size mm 前端尺寸	OAL mm 全长	Blade length mm 轴长	Blade diameter mmφ 轴径	Handle diameter mmφ 手柄直径	Weight g 重量
D-66	⊕ No.00	51	23	1.8	7.0	1.5
D-67	⊖ 1.8×0.3					

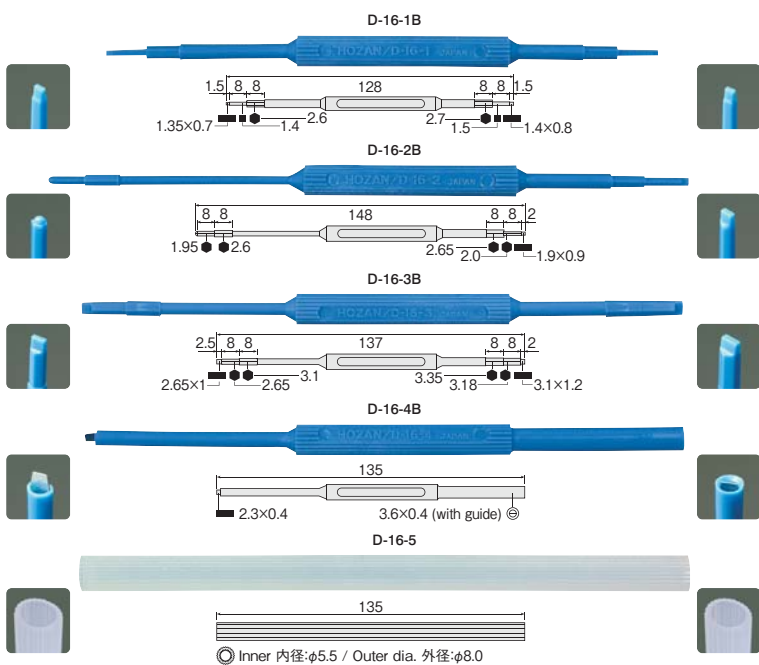

D-16 **ALIGNMENT TOOL KIT**
核心螺丝刀组

Set contents 配置明细	D-16-1B/D-16-2B/D-16-3B/ D-16-4B/D-16-5
Color 色	D-16-1B to 4B Blue / D-16-5 White D-16-1B~4B 青色 / D-16-5 白色
Weight 重量	45g

ALIGNMENT TOOL
核心螺丝刀

Part no. 型号	Tip size mm 前端尺寸	Weight g 重量
D-16-1B	■ 1.35×0.7 • 1.4×0.8 ■ 1.4 • 1.5 ● 2.6 • 2.7	3
D-16-2B	■ 1.9×0.9 ● 1.95 • 2.0 • 2.6 • 2.65	
D-16-3B	■ 2.65×1 • 3.1×1.2 ● 2.65 • 3.1 • 3.18 • 3.35	
D-16-4B	■ 2.3×0.4 ◎ 3.6×0.4 (with guide)	4
D-16-5	◎ Inner 内径: φ5.5 Outer dia. 外径: φ8.0	3

*Unnecessary sizes can be cut, and then used.
※不要的尺寸可以切掉。

W-510 **SOCKET WRENCH SET**
套筒扳手

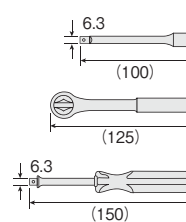

Socket size 套筒形状	6.3mm square (1/4" sq) 6.3mm角 (1/4" sq)
Pouch dimensions 工具包尺寸	160×75×35mm
Weight 重量	430g

Set contents 配置明细	Part no. 型号	Weight g 重量
Ratchet handle 棘轮手柄	6.3 mm square 角	
Screwdriver type handle 扳手手柄	6.3 mm square 角	
Extension bar 接杆	100 mm	
Socket (6.3mm square) 套筒 (6.3mm角)	4 mm	
ditto	4.5 mm	
ditto	5 mm	
ditto	5.5 mm	
ditto	6 mm	
ditto	7 mm	
ditto	8 mm	
ditto	9 mm	
ditto	10 mm	
ditto	12 mm	



BALLPOINT L-WRENCH SET
L型长柄球扳手组

Part no. 型号	Weight g 重量
W-110	130
W-111	117
W-112	83
W-113	74



W-110

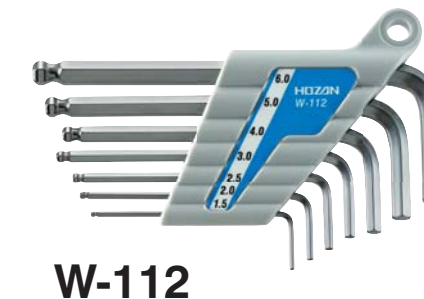

W-112



W-111



W-113

BALLPOINT L-WRENCH
L型长柄球扳手

Part no. 型号	Width-across-flats size mm 对边尺寸	Inclination angle 倾斜角		Hex recessed head bolt 六角螺栓	Hex recessed set screw 六角螺丝	Weight g 重量	
		16°	20°				
W-110 single item W-110单个项目	W-110-1.5	1.5	14	80	M1.6/M2	M3	2
	W-110-2	2.0	16	96	M2.5	M4	3
	W-110-2.5	2.5	18	111	M3	M5	6
	W-110-3	3.0	20	127	M4	M6	9
	W-110-4	4.0	25	142	M5	M8	18
	W-110-5	5.0	28	160	M6	M10	31
W-111 single item W-111单个项目	W-111-1.5	1.5	4	81	M1.6/M2	M3	2
	W-111-2	2.0	5	96	M2.5	M4	3
	W-111-2.5	2.5	6	111	M3	M5	5
	W-111-3	3.0	8	127	M4	M6	8
	W-111-4	4.0	9	142	M5	M8	16
	W-111-5	5.0	11	160	M6	M10	28
W-112 single item W-112单个项目	W-112-1.5	1.5	14	51	M1.6/M2	M3	1
	W-112-2	2.0	16	58	M2.5	M4	2
	W-112-2.5	2.5	18	65	M3	M5	3
	W-112-3	3.0	20	74	M4	M6	6
	W-112-4	4.0	25	78	M5	M8	11
	W-112-5	5.0	28	89	M6	M10	19
W-113 single item W-113单个项目	W-113-1.5	1.5	4	51	M1.6/M2	M3	1
	W-113-2	2.0	5	58	M2.5	M4	2
	W-113-2.5	2.5	6	65	M3	M5	3
	W-113-3	3.0	8	74	M4	M6	5
	W-113-4	4.0	9	78	M5	M8	9
	W-113-5	5.0	11	89	M6	M10	17
W-113-6	6.0	13	101	M8	M12	27	

With dial lock
带密码锁

With shoulder belt
带肩背带

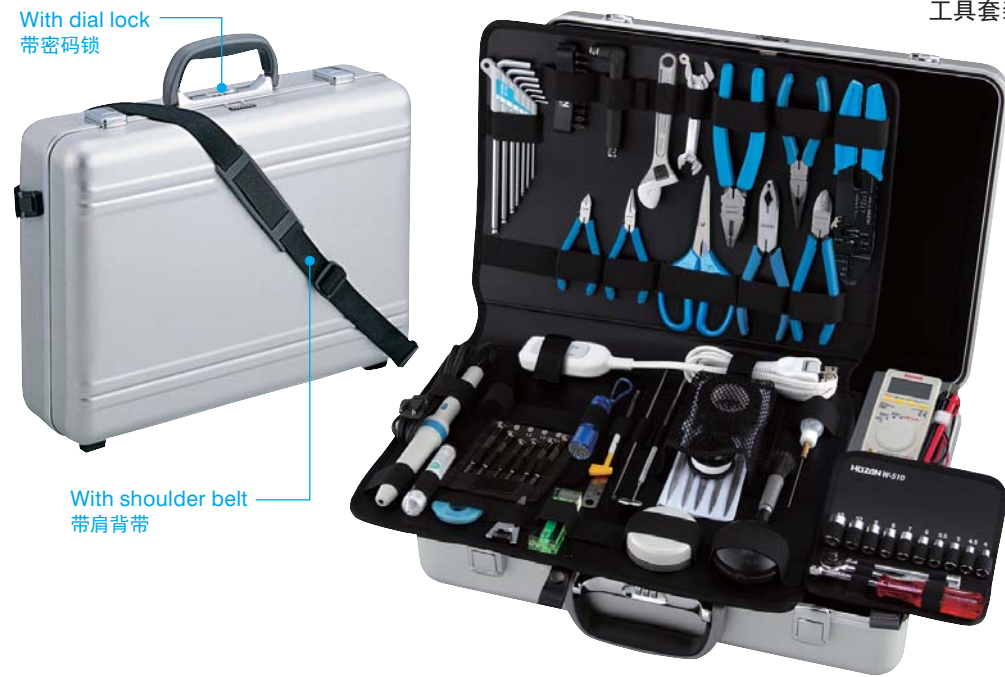

S-80/S-80-230 100V 230V

TOOL KIT
工具套装

External dimensions mm 外形尺寸	Weight kg 重量
460 (W) x 340 (H) x 145 (D)	7



Tool pallet (top) rear face
工具插板 (箱盖侧) 的背面

Details table (kit contents: 78 pieces)

明細表 (套装内容 78件)

Precision Screwdriver 精密螺丝刀	⊕No.0	D-20-11	Solder Aid Tool Kit (Hook and Reamer) 锡焊辅助工具组 (钩·刮刀)	H-740-1
Ditto	⊕No.1	D-20-12	Ditto (Knife and Scraper) (小刀·刮板)	H-740-2
Ditto	⊖1.2	D-20-14	Ditto (Brush and Foil) (电刷·箔)	H-740-3
Ditto	⊖1.8	D-20-15	Lead-free Solder 无铅焊料	HS-363
Ditto	⊖2.3	D-20-16	Desolder Braid 焊锡吸取线	HS-380-2.5
Ditto	⊖3.0	D-20-17	File Round 锉刀 圆	
Alignment Tool 高周波螺丝刀		D-29-100	Ditto Half-round * 半圆	
Reversible Slubby Screwdriver 高周波螺丝刀	⊕No.2/⊖6.0	D-59	Ditto Crochet * 两个半圆	
Electrician's Slotted Screwdriver 电工螺丝刀	⊖6.0	D-331-100	Ditto Oval * 椭圆	
Electrician's Phillips Screwdriver 电工十字螺丝刀	⊕No.2	D-332-100	Ditto Hand * 平	
Phillips Screwdriver 螺丝螺丝刀	⊕No.00	D-530-75	Ditto Hand (Flat) * 平 (枪型)	K-215
Ditto	⊕No.0	D-540-100	Ditto Knife * 刀刀	
Ditto	⊕No.1	D-550-100	Ditto Triangular * 三角	
Ditto	⊕No.2	D-555-100	Ditto Triangular (Flat Leaf) * 三角 (单刀)	
Slotted Screwdriver 一字螺丝刀	⊖2.5	D-630-75	Ditto Square * 角	
Ditto	⊖4.0	D-640-100	Slide-Out Magnifier 放大镜	L-98
Ditto	⊖5.0	D-650-100	Diagonal Cutter with Stripper 镊子	N-9-150
Ditto	⊖5.5	D-655-100	Miniature Diagonal Cutter 小型钳子	N-31
Soldering Iron Stand 烙铁架	H-11		Snips 蛇口剪	N-838
Soldering Iron with Booster 可调压式电烙铁	H-600		Long Nose Pliers with Side Cutter 尖头钳	P-15-150
			Miniature Long Nose Pliers 小型尖头钳	P-35

Lineman's Pliers 钢丝钳	P-43-175
Spring Hook 弹簧挂钩	P-64
Reverse Action Tweezers 自锁镊子	P-89
Crimping Tool 压着钳	P-704
Stainless Probe (Key) 不锈钢探头 (钥匙)	P-808
Curved Tweezers 弯头镊子	P-882
Ditto Tweezers 强力型镊子	P-891
Flat Wrench 5.5x7mm 角度扳手	
Ditto 8x10mm *	W-76
Ditto 12x14mm *	
Hex Lobular Wrench Set (16/18/10/115/120/125/127/130) 星型螺丝刀组	W-81
⊕No.2x⊖6.0(⊕No.1x⊖4.5)	
Ballpoint L-wrench L型长柄球扳手	1.5mm
Ditto *	2.0mm
Ditto *	2.5mm
Ditto *	3.0mm
Ditto *	4.0mm
Ditto *	5.0mm
Ditto *	6.0mm
Adjustable Wrench 活动扳手	W-230-150

Socket Wrench Set (1/4, 3/8, 5/8, 7/8, 9/10, 12mm) 套筒扳手	W-510
Precision Oiler 注油器	Z-64
Rubber Blower with Extension Nozzle 伸缩式吹气球	Z-261
Level Gauge 水平器	Z-340
Measure Tape 丙稀水平仪	Z-341
Inspection Mirror 检查镜	Z-350
LED Pocket Light LED掌上灯	
Utility Knife 裁纸刀	
Shielding Tape 密封带	
Table Tap 排插	
Digital Multimeter 数字万用表	
Screw Pliers 螺丝钳	
Heat Sink 散热器	
Electrical Tape 塑料胶带	
Steel Rule 150 mm 钢直尺 150mm	
Hex Wrench 内六角扳手 0.7mm	
Ditto *	0.8mm
Ditto *	1.2mm

Accessory: Tool Case, Tool pallet, Shoulder belt
附工具箱、工具插板、带肩背带

With dial lock
带密码锁

With shoulder belt
带肩背带



S-81/S-81-230 100V 230V

TOOL KIT
工具套装

External dimensions mm 外形尺寸	Weight kg 重量
365 (W) x 275 (H) x 110 (D)	3.5

Details table (kit contents: 32 pieces)

明細表 (套装内容 32件)

Precision Screwdriver 精密螺丝刀	⊕No.0	D-20-11	Long Nose Pliers with Side Cutter 尖头钳	P-15-150
Ditto	⊕No.1	D-20-12	Slip Joint Pliers 鲤鱼钳	P-2112-150
Ditto	⊖1.2	D-20-14	Crimping Tool 压着钳	P-704
Ditto	⊖1.8	D-20-15	Tweezers 强力型镊子	P-891
Ditto	⊖2.3	D-20-16	Ballpoint L-wrench 圆珠笔扳手	1.5mm
Ditto	⊖3.0	D-20-17	Ditto *	2.0mm
Reversible Screwdriver 可翻转螺丝刀	⊕No.00/⊖2.5	D-52	Ditto *	2.5mm
Ditto	⊕No.1/⊖4.0	D-54	Ditto *	3.0mm
Ditto	⊕No.2/⊖5.5	D-58	Ditto *	4.0mm
Soldering Iron Stand 烙铁架	H-11		Ditto *	5.0mm
Soldering Iron with Booster 可调压式电烙铁	H-600		Ditto *	6.0mm
Lead-free Solder 无铅焊料	HS-363		Adjustable Wrench 活动扳手	W-230-150
Desolder Braid 吸锡线	HS-380-2.5		Measure Tape 卷尺	Z-341
Slide-Out Magnifier 放大镜	L-98		LED Pocket Light LED掌上灯	
Diagonal Cutter with Stripper 镊子	N-9-150		Utility Knife 裁纸刀	
Snips 蛇口剪	N-838		Digital Multimeter 数字万用表	

Accessory: Tool Case, Tool pallet, Shoulder belt
附工具箱、工具插板、带肩背带



S-201/S-201-230 100V 230V

TOOL KIT
工具套装

External dimensions mm 外形尺寸	Weight kg 重量
445 (W) x 335 (H) x 200 (D)	5.8

Details table (kit contents: 37 pieces)

明細表 (套装内容 37件)

Precision Screwdriver 精密螺丝刀	⊕No.0	D-20-11	Long Nose Pliers with Side Cutter 尖嘴钳	P-15-150
Ditto	⊕No.1	D-20-12	Lineman's Pliers 钢丝钳	P-43-175
Ditto	⊖1.2	D-20-14	Tweezers 镊子	P-880
Ditto	⊖1.8	D-20-15	Hex Wrench 六角扳手	0.7mm
Ditto	⊖2.3	D-20-16	Ditto *	0.89mm
Ditto	⊖3.0	D-20-17	Ditto *	1.27mm
Reversible Screwdriver 可翻转螺丝刀	⊕No.00/⊖2.5	D-52	Ditto *	1.5mm
Ditto	⊕No.1/⊖4.0	D-54	Ditto *	1.6mm
Phillips Screwdriver 十字螺丝刀	⊕No.0	D-540-100	Ditto *	2.0mm
Ditto	⊕No.2	D-555-100	Ditto *	2.5mm
Slotted Screwdriver 扁口螺丝刀	⊖5.5	D-655-100	Ditto *	3.0mm
Nut Driver 螺母螺丝刀	5.5mm	D-840-5.5	Ditto *	4.0mm
Ditto	7mm	D-840-7	Adjustable Wrench 单头扳手	W-230-150
Soldering Iron Stand 烙铁架	H-11		Measure Tape 卷尺	Z-341
Soldering Iron with Cap 带帽电烙铁	H-250		Screw Pliers 螺丝钳	
Solder 锡线	H-700		Utility Knife 裁纸刀	
Diagonal Cutter with Stripper 剪钳	N-9-150		Work Gloves 工作手套	
Snips 强力斜口剪	N-838		Caster Wheels (2 pieces) 铸工 (2件)	
Desolder Braid 焊锡吸取器	No.3738			

Accessory: Tool Bag, Tool pallet, Shoulder belt, Rain cover
附脚轮袋、工具插板、带肩背带、雨罩

S-372

TOOL KIT
工具套装

External dimensions mm 外形尺寸	Weight kg 重量
390 (W) x 350 (H) x 180 (D)	2.6

Details table (kit contents: 24 pieces)

明細表 (套装内容 24件)

Reversible Screwdriver 可翻转螺丝刀	⊕No.00/⊖2.5	D-52	Hex Wrench 六角扳手	1.27mm
Ditto	⊕No.1/⊖4.0	D-54	Ditto *	1.5mm
Ditto	⊕No.2/⊖5.5	D-58	Ditto *	1.6mm
Diagonal Cutter with Stripper 剪钳	N-9-150		Ditto *	2.0mm
Snips 强力斜口剪	N-838		Ditto *	2.4mm
Long Nose Pliers with Side Cutter 尖嘴钳	P-15-150		Ditto *	3.0mm
Tweezers 镊子	P-87		Ditto *	3.2mm
Slip Joint Pliers 鲤鱼钳	P-2112-150		Adjustable Wrench 单头扳手	W-230-150
Flat Wrench 角度扳手	5.5x7mm		Measure Tape 卷尺	Z-341
Ditto *	8x10mm	W-76	Screw Pliers 螺丝钳	
Ditto *	12x14mm		LED Pocket Light LED掌上灯	
			Utility Knife 裁纸刀	
			Work Gloves 工作手套	

Accessory: Tool Bag, Tool pallet
附手提包、工具插板

S-7/S-7-230 100V 230V

TOOL KIT
工具套装

External dimensions mm 外形尺寸	Weight kg 重量
300 (W) x 200 (H) x 80 (D)	2.2

Details table (kit contents: 17 pieces)

明細表 (套装内容 17件)

Alignment Tool 调整用螺丝刀	D-29-100	Diagonal Cutter 斜口钳	N-4-125	
Phillips Screwdriver 十字螺丝刀	⊕No.0	D-540-100	Long Nose Pliers with Side Cutter 尖嘴钳	P-15-150
Ditto	⊕No.2	D-555-100	Lineman's Pliers 钢丝钳	P-43-150
Slotted Screwdriver 扁口螺丝刀	⊖2.5	D-630-100	Tweezers 镊子	P-87
Ditto *	⊖4.0	D-640-100	Adjustable Wrench 单头扳手	W-230-150
Nut Driver 螺母螺丝刀	D-840-5.5	Measure Tape 卷尺	Z-341	
Soldering Iron 耐隔热烙铁	H-869	Solder 焊锡		
File Hand 锉刀 平	K-172	Utility Knife 裁纸刀		
		Electrical Tape 塑料胶带		

Accessory: Tool Case
附工具箱



S-76/S-76-230 100V 230V
TOOL KIT
 工具套装

External dimensions mm 外形尺寸	Weight kg 重量
450 (W) x 330 (H) x 140 (D)	4

Details table (kit contents: 49 pieces)
 明細表 (套装内容 49件)

Roll-Up Pouch 工具包 B-712	Long Nose Pliers with Side Cutter 尖嘴钳 P-15-150
Precision Screwdriver 精密螺丝刀 ⊕No.0 D-20-11	Lineman's Pliers 钢丝钳 P-43-175
Ditto * ⊕No.1 D-20-12	Spring Hook 弹簧钩 P-64
Ditto * ⊕1.2 D-20-14	Slip Joint Pliers 鲤鱼钳 P-211Z-150
Ditto * ⊕1.8 D-20-15	Crimping Tool 压接钳 P-704
Ditto * ⊕2.3 D-20-16	Stainless Probe 不锈钢探针 P-808
Ditto * ⊕3.0 D-20-17	Tweezers 镊子 P-880
Reversible Stubby Screwdriver 可替换螺丝刀 ⊕No.2/⊖6.0 D-59	Hex Wrench 六角扳手 0.71mm
Phillips Screwdriver 十字螺丝刀 ⊕No.00 D-530-75	Ditto * 0.89mm
Ditto * ⊕No.0 D-540-100	Ditto * 1.27mm
Ditto * ⊕No.1 D-550-100	Ditto * 1.5mm
Ditto * ⊕No.2 D-555-100	Ditto * 1.6mm
Slotted Screwdriver 扁口螺丝刀 ⊕2.5 D-630-75	Ditto * 2.0mm
Ditto * ⊕4.0 D-640-100	Ditto * 2.5mm
Ditto * ⊕5.0 D-650-100	Ditto * 3.0mm
Ditto * ⊕5.5 D-655-100	Ditto * 4.0mm
Nut Driver 螺母螺丝刀 5.5mm D-840-5.5	Adjustable Wrench 单头扳手 W-230-150
Ditto * 7mm D-840-7	Rubber Blower with Extension Nozzle 加长橡胶吹气球 Z-261
Soldering Iron Stand 置烙铁台 H-11	Measure Tape 卷尺 Z-341
Soldering Iron with Booster 即热式烙铁 H-600	Inspection Mirror 检查镜 Z-350
Lead-free Solder 锡线 HS-363	LED Pocket Light LED掌上灯
Desolder Braid 吸锡线 HS-380-2.5	File Round 锉刀 圆
Diagonal Cutter with Stripper 剪钳 N-9-150	Ditto Hand * 平
Snips 强力斜口剪钳 N-838	Utility Knife 裁纸刀
	Voltage Checker 检电螺丝刀

- Accessory: Tool Case, Tool pallet,
- 附工具箱、工具插板



S-75/S-75-230 100V 230V
TOOL KIT
 工具套装

External dimensions mm 外形尺寸	Weight kg 重量
450 (W) x 330 (H) x 140 (D)	5.7



Tool Pallet, B (bottom side) rear face
 工具插板B (本体侧) 背面

Details table (kit contents: 74 pieces)
 明細表 (套装内容 74件)

Electrician's Slotted Screwdriver 电工螺丝刀 ⊖6.0 D-331-100	Diagonal Cutter with Stripper 剪钳 N-9-125
Ditto * ⊕No.2 D-332-100	Miniature Diagonal Cutter 小型斜口剪钳 N-32
Phillips Screwdriver 十字螺丝刀 ⊕No.00 D-530-75	Snips 强力斜口剪钳 N-838
Ditto * ⊕No.0 D-540-100	Long Nose Pliers with Side Cutter 尖嘴钳 P-15-150
Ditto * ⊕No.1 D-550-100	Miniature Long Nose Pliers 小型尖嘴钳 P-36
Ditto * ⊕No.2 D-555-100	Lineman's Pliers 钢丝钳 P-43-150
Slotted Screwdriver 扁口螺丝刀 ⊕2.5 D-630-75	Spring Hook 弹簧钩 P-64
Ditto * ⊕2.5 D-630-100	Reverse Action Tweezers 反作用镊子 P-89
Ditto * ⊕4.0 D-640-100	Slip Joint Pliers 鲤鱼钳 P-211Z-150
Ditto * ⊕5.0 D-650-100	Crimping Tool 压接钳 P-704
Ditto * ⊕5.5 D-655-100	Tweezers 镊子 P-880
Nut Driver 螺母螺丝刀 5.5mm D-840-5.5	Wire Stripper 剥线钳 P-968
Ditto * 7mm D-840-7	Flat Wrench 角度扳手套 5.5x7mm
Soldering Iron Stand 置烙铁台 H-11	Ditto * 8x10mm
Soldering Iron with Booster 即热式烙铁 H-600	Ditto * 12x14mm
Solder Kit Tool Kit (Pencil and Reamer) 锡焊工具组 (烙铁、刮刀) H-740-1	Hex Wrench 六角扳手 1.27mm
Ditto (Knife and Scope) * (小刀、刮板) H-740-2	Ditto * 1.5mm
Ditto (Brush and Fork) * (电刷叉子) H-740-3	Ditto * 1.6mm
Lead-free Solder 锡线 HS-363	Ditto * 2.0mm
Desolder Braid 吸锡线 HS-380-2.5	Ditto * 2.4mm
File Round 精密锉 圆	Ditto * 3.0mm
Ditto Half-Round * 半圆	Ditto * 3.2mm
Ditto Crochet * 圆半丸	Adjustable Wrench 活动扳手 W-230-150
Ditto Oval * 橢圓	Measure Tape 卷尺 Z-341
Ditto Hand * 平	LED Pocket Light LED掌上灯
Ditto Hand (Flat) * 平 (枪型)	Steel Rule 钢尺 150 mm
Ditto Knife * 刀刃	Utility Knife 裁纸刀
Ditto Triangular * 三角	Screw Case 螺丝盒
Ditto Frat Leaf * 三角 (片刃)	Heat Sink 散热器
Ditto Square * 角	Voltage Checker 检电螺丝刀

- Accessory: Tool Case, Tool pallet
- 附工具箱、工具插板



S-60-B/S-60-B230 100V 230V
TOOL KIT
 工具套装

External dimensions mm 外形尺寸	Weight kg 重量
450 (W) x 330 (H) x 140 (D)	4.3

Details table (kit contents: 28 pieces)
 明細表 (套装内容 28件)

Parts Box 储盒 B-10-AB	Tweezers 镊子 P-880
Reversible Screwdriver 可替换螺丝刀 ⊕No.00 ⊖4.0 D-52	Hex Wrench 六角扳手 1.27mm
Ditto * ⊕No.1 ⊖4.0 D-54	Ditto * 1.5mm
Ditto * ⊕No.2 ⊖5.5 D-58	Ditto * 1.6mm
Reversible Stubby Screwdriver 可替换尖嘴螺丝刀 ⊕No.2/⊖6.0 D-59	Ditto * 2.0mm
	Ditto * 2.4mm
Soldering Iron Stand 置烙铁台 H-11	Ditto * 3.0mm
Soldering Iron with Cap 带帽烙铁 H-250	Ditto * 3.2mm
Solder 锡线 H-700	Adjustable Wrench 单头扳手 W-230-150
Diagonal Cutter with Stripper 斜口钳 N-5-150	LED Pocket Light LED掌上灯
Desolder Braid 焊接吸取器 No.3738	Utility Knife 裁纸刀
Long Nose Pliers with Side Cutter 尖嘴钳 P-15-150	Service Mat 服务垫
Spring Hook 弹簧钩 P-64	File Hand 精密锉刀 平
Slip Joint Pliers 鲤鱼钳 P-211Z-150	Ditto Round * 丸
	Electrical Tape 塑料胶带
	附工具箱、工具插板

S-22/S-22-230 100V 230V
TOOL KIT
 工具套装

External dimensions mm 外形尺寸	Weight kg 重量
330 (W) x 240 (H) x 68 (D)	2.0



Details table (kit contents: 20 pieces)
 明細表 (套装内容 20件)

Nut Driver 螺母螺丝刀 5.5mm D-840-5.5	Tip Cleaning Tray 烙铁头清洁器 H-8
Solder 锡线 H-700	Solder Kit Tool Kit (Knife and Scope) 锡焊工具组 (小刀、刮板) H-740-2
Ditto (Brush and Fork) * (电刷叉子) H-740-3	Soldering Iron 耐腐烙铁手柄 H-869
Soldering Iron 耐腐烙铁手柄 H-869	Diagonal Cutter with Stripper 剪钳 N-9-150
Diagonal Cutter with Stripper 剪钳 N-9-150	Long Nose Pliers with Side Cutter 尖嘴钳 P-15-150
Alignment Tool 调整用螺丝刀 D-29-100	Lineman's Pliers 钢丝钳 P-43-150
Phillips Screwdriver 十字螺丝刀 ⊕No.0 D-540-100	Tweezers 镊子 P-86-125
Phillips Screwdriver * ⊕No.2 D-555-100	Adjustable Wrench 单头扳手 W-230-150
Slotted Screwdriver 扁口螺丝刀 ⊕2.5 D-630-100	Measure Tape 卷尺 Z-341
Slotted Screwdriver * ⊕4.0 D-640-100	Heat Sink 散热器
	File Hand 锉刀 平
	Ditto Round * 丸
	附工具箱

S-10/S-10-230 100V 230V
TOOL KIT
 工具套装

External dimensions mm 外形尺寸	Weight kg 重量
320 (W) x 200 (H) x 40 (D)	2.1



Details table (kit contents: 20 pieces)
 明細表 (套装内容 20件)

Alignment Tool 调整用螺丝刀 D-29-100	Adjustable Wrench 单头扳手 W-230-150
Phillips Screwdriver 十字螺丝刀 ⊕No.0 D-540-100	Utility Knife 裁纸刀
Ditto * ⊕No.2 D-555-100	Electrical Tape 塑料胶带
Slotted Screwdriver 扁口螺丝刀 ⊕2.5 D-630-100	File Hand 锉刀组 平
	Ditto Round * 丸
	附工具箱



S-35/S-35-230

TOOL KIT
工具套装

External dimensions mm 外形尺寸	Weight kg 重量
260 (W) x 145 (H) x 35 (D)	1.4

Details table (kit contents: 13 pieces)
明細表 (套装内容 13件)

Phillips Screwdriver 十字螺丝刀 ⊕No.0 D-540-100	Desolder Braid 焊接吸器 No.3738
Ditto * ⊕No.1 D-550-100	Long Nose Pliers with Side Cutter 尖嘴钳 P-15-150
Ditto * ⊕No.2 D-555-100	Lineman's Pliers 钢丝钳 P-43-150
Slotted Screwdriver 扁口螺丝刀 ⊖2.5 D-630-100	Tweezers 镊子 P-87
Ditto * ⊖4.0 D-640-100	Adjustable Wrench 单头扳手 W-230-150
Soldering Iron with Cap 带帽烙铁把手 H-250	Solder 锡线
Diagonal Cutter with Stripper 剪钳 N-9-125	Accessory: Tool Case 附工具箱



S-34/S-34-230

TOOL KIT
工具套装

External dimensions mm 外形尺寸	Weight kg 重量
260 (W) x 145 (H) x 35 (D)	1.0

Details table (kit contents: 10 pieces)
明細表 (套装内容 10件)

Phillips Screwdriver 十字螺丝刀 ⊕No.0 D-540-100	Diagonal Cutter 斜口剪钳 125 mm
Ditto * ⊕No.2 D-555-100	Long Nose Pliers 尖头钳 150 mm
Slotted Screwdriver 扁口螺丝刀 ⊖2.5 D-630-75	Solder 锡线
Ditto * ⊖4.0 D-640-100	File Hand 锉刀平
Soldering Iron with Cap 带帽烙铁把手 H-250	Accessory: Tool Case 附工具箱
Tweezers 镊子 P-87	



S-3
TOOL KIT
工具套装

External dimensions mm 外形尺寸	Weight kg 重量
260 (W) x 145 (H) x 35 (D)	1.0

Details table (kit contents: 21 pieces)
明細表 (套装内容 21件)

Phillips Screwdriver 十字螺丝刀 ⊕No.00 D-530-75	Hex Wrench 六角扳手 1.27mm
Ditto * ⊕No.0 D-540-100	Ditto * 1.5mm
Ditto * ⊕No.2 D-555-100	Ditto * 1.6mm
Slotted Screwdriver 扁口螺丝刀 ⊖2.5 D-630-75	Ditto * 2.0mm W-91
Ditto * ⊖4.0 D-640-100	Ditto * 2.4mm
Miniature Diagonal Cutter 小型斜口剪钳 N-32	Ditto * 3.0mm
Miniature Long Nose Pliers 小型尖头钳 P-36	Ditto * 3.2mm
Tweezers 镊子 P-880	Utility Knife 裁纸刀
Flat Wrench 角度扳手 5.5x7mm	File Hand 锉刀组平
Ditto * 8x10mm W-76	File Round * 丸
Ditto * 12x14mm	Accessory: Tool Case 附工具箱



S-1
TOOL KIT
工具套装

External dimensions mm 外形尺寸	Weight kg 重量
153 (W) x 82 (H) x 25 (D)	0.3

Details table (kit contents: 7 pieces)
明細表 (套装内容 7件)

Phillips Screwdriver 十字螺丝刀 ⊕No.00 D-530-75	
Ditto * ⊕No.2	
Slotted Screwdriver 扁口螺丝刀 ⊖2.5 D-630-75	
Ditto * ⊖4.0	
Miniature Diagonal Cutter 小型斜口剪钳 N-31	
Miniature Long Nose Pliers 小型尖头钳 P-36	
Tweezers 镊子 P-87	
Accessory: Tool Case 附工具箱	



F-735/F-736
ESD CUSHION MATS
抗疲劳地垫



Part no. 型号	External dimensions mm 外形尺寸	Thickness mm 厚度	ESD standard Ω 防静电管理值	Weight kg 重量	Quantity 数量
F-735	900 (W) x 600 (D)	12.7	Rg ≤ 1×10 ⁷	18	5
F-736				3.5	1

■ The ground cord is not provided as an accessory. It can be ordered separately.
■ 标配没有地线, 如客户有需求请选购F-127

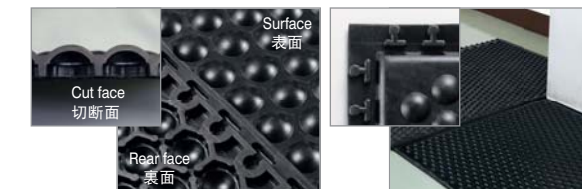

Eases fatigue from standing
减轻腿部的疲劳

A jointed construction allows
expansion to the desired size
可自由组合尺寸

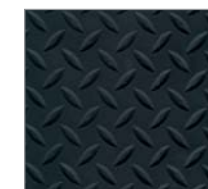
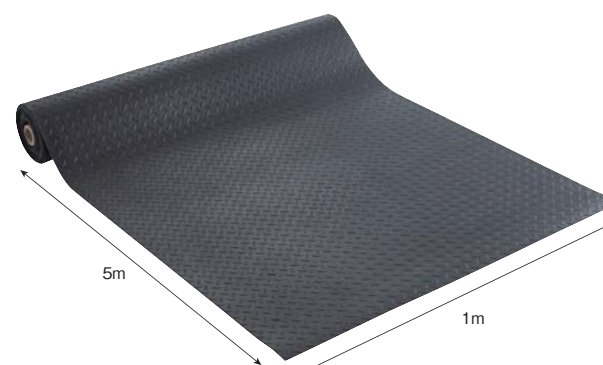

F-730
ESD FLOOR MAT
防静电地垫



External dimensions mm 外形尺寸	Thickness mm 厚度	ESD standard Ω 防静电管理值	Weight kg 重量
1 (W) x 5 (L)	4	Rg ≤ 1×10 ⁸	27

■ The ground cord is not provided as an accessory. It can be ordered separately.
■ 标配没有地线, 如客户有需求请选购F-127

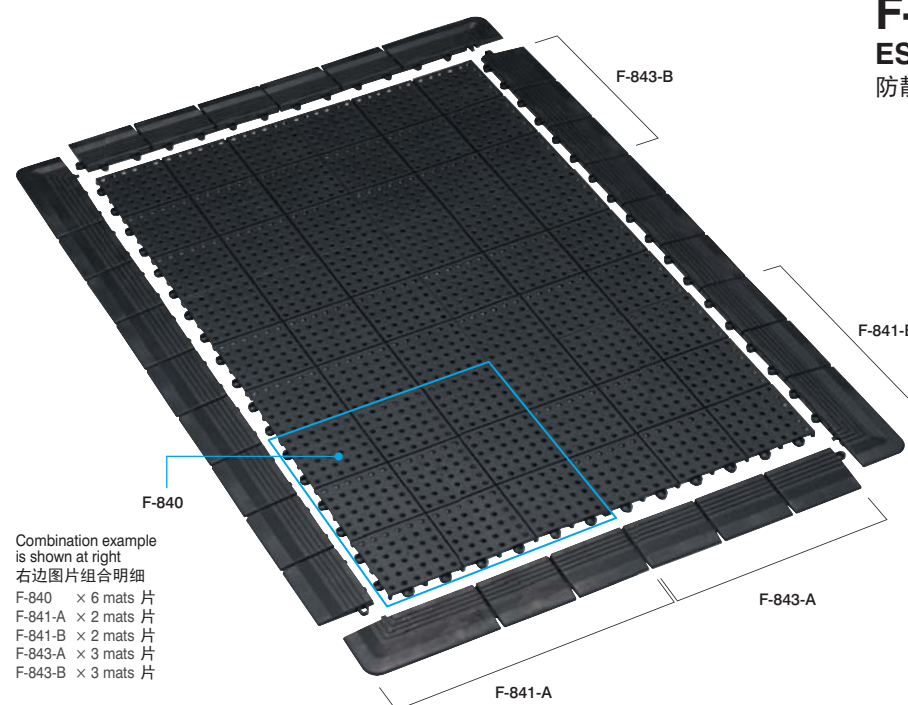

Combination example
is shown at right
右边图片组合明細
F-840 × 6 mats 片
F-841-A × 2 mats 片
F-841-B × 2 mats 片
F-843-A × 3 mats 片
F-843-B × 3 mats 片

Ground by running an available M5 x 8 screw (with nut & washer) through the F-840 hole, and connecting it to a stranded copper wire of 1.25 mm² or larger, the other end to ground.

关于接地
F-840的地线孔可对应市面上卖的,
M5×8的接地线, 请放心使用

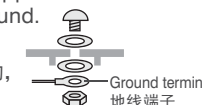

F-840~F-843
ESD FLOOR MATS
防静电地垫

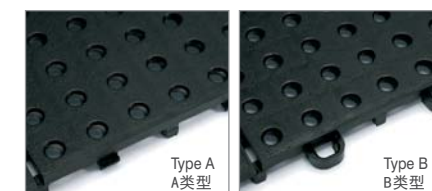

		750			
		F-843-B	F-841-B		
F-841-A	F-840	F-840	F-843-B		
F-843-A	F-840	F-840	F-843-B	1050	
F-843-A	F-840	F-840	F-841-B		
		F-841-A	F-843-A		

Part No. 型号	Part Name 品名	External dimensions mm 外形尺寸	Thickness mm 厚度	ESD standard Ω 防静电管理值	Weight g 重量
F-840	ESD Floor Mat	300 (W) x 300 (D)	10	Rg ≤ 1×10 ⁷	310
F-841-A	ESD Floor Mat (Type A)	75 (W) x 375 (D)			150
F-841-B	ESD Floor Mat (Type B)				150
F-843-A	ESD Floor Mat (Type A)	75 (W) x 300 (D)			120
F-843-B	ESD Floor Mat (Type B)		120		

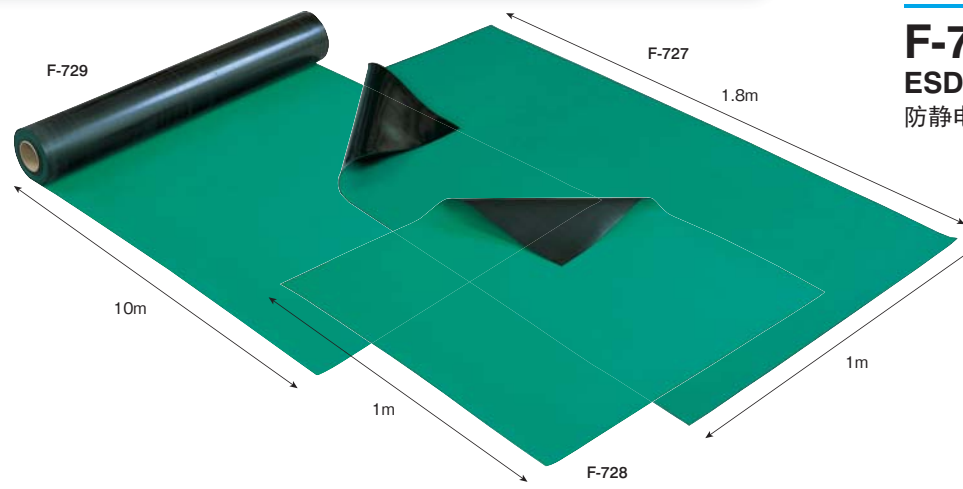

F-727/F-728/F-729
ESD RUBBER MATS (Green)
防静电台垫 (绿色)

Part no. 型号	External dimensions m 外形尺寸	Weight kg 重量	Thickness mm 厚度	ESD standard Ω 防静电管理值
F-728	1 (W) × 1 (L)	3.4	2	Rp ≤ 1 × 10 ⁹
F-727	1 (W) × 1.8 (L)	6.2		
F-729	1 (W) × 10 (L)	34.4		

- Reinforcement fibers layer inside.
- The ground cord is not provided as an accessory. It can be ordered separately.
- 材质含强化纤维。
- 不配接地线。请其它途径购买F-127或F-27。

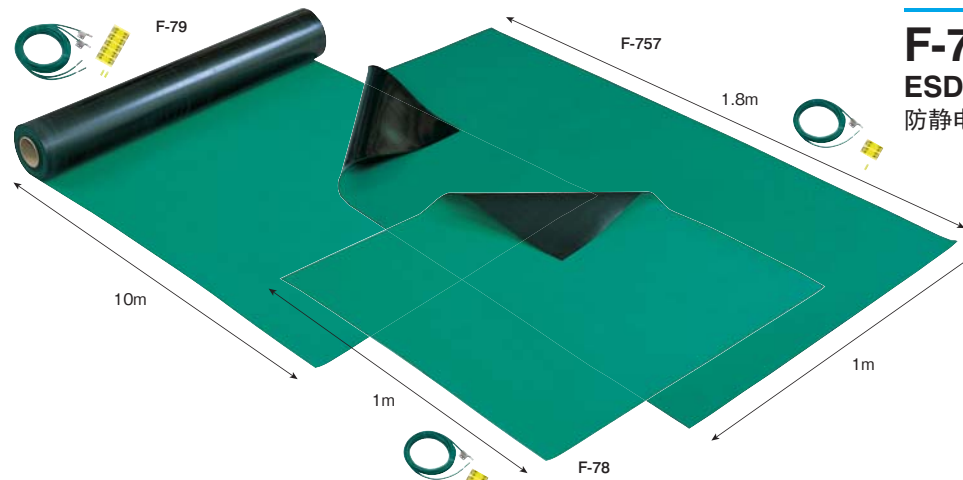

F-78/F-79/F-757
ESD RUBBER MATS (Green)
防静电台垫 (绿色)

Part no. 型号	External dimensions m 外形尺寸	Weight kg 重量	Thickness mm 厚度	ESD standard Ω 防静电管理值
F-78	1 (W) × 1 (L)	3	2	Rp ≤ 1 × 10 ⁹
F-757	1 (W) × 1.8 (L)	5.5		
F-79	1 (W) × 10 (L)	30.5		

- Reinforcement fibers layer inside.
- F-78 / F-757 ground cord × 1, F-79 ground cord × 2
- 材质含强化纤维。
- F-78/F-757 配地线1根, F-79 标配地线二根

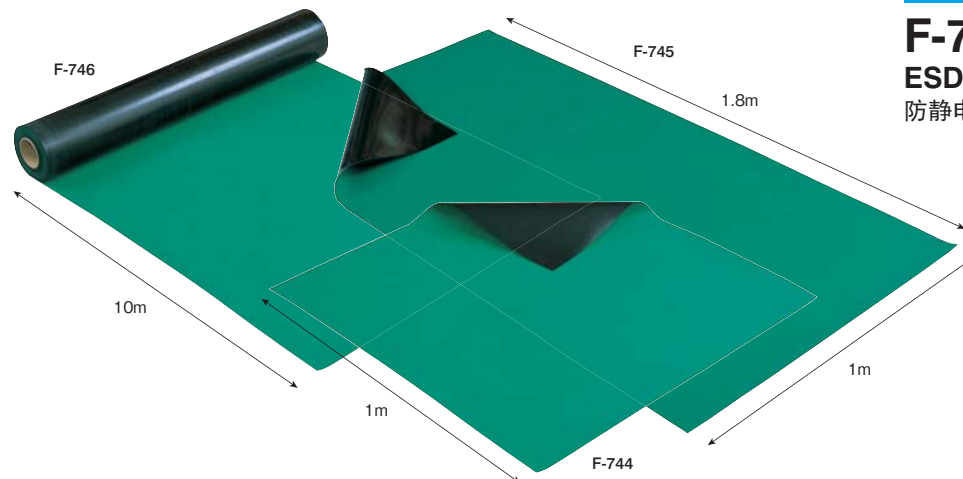

F-744/F-745/F-746
ESD RUBBER MATS (Green)
防静电台垫 (绿色)

Part no. 型号	External dimensions m 外形尺寸	Weight kg 重量	Thickness mm 厚度	ESD standard Ω 防静电管理值
F-744	1 (W) × 1 (L)	3	2	Rp ≤ 1 × 10 ⁹
F-745	1 (W) × 1.8 (L)	5.3		
F-746	1 (W) × 10 (L)	29.6		

- The ground cord is not provided as an accessory. It can be ordered separately.
- 不配接地线。请其它途径购买F-127或F-27。

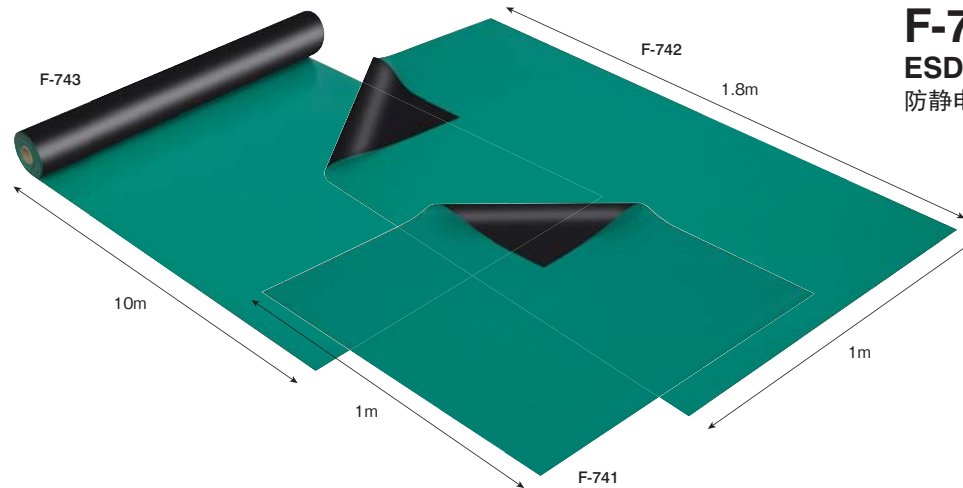

F-741/F-742/F-743
ESD RUBBER MATS (Green)
防静电台垫 (绿色)

Part no. 型号	External dimensions m 外形尺寸	Weight kg 重量	Thickness mm 厚度	ESD standard Ω 防静电管理值
F-741	1 (W) × 1 (L)	2.2	1.5	Rp ≤ 1 × 10 ⁹
F-742	1 (W) × 1.8 (L)	4.0		
F-743	1 (W) × 10 (L)	22.2		

- The ground cord is not provided as an accessory. It can be ordered separately.
- 不配接地线。请其它途径购买F-127或F-27。



F-310-S/M/L
ESD DESK MAT
防静电桌垫

Part no. 型号	ESD standard 防静电管理值	External dimensions m 外形尺寸	Hook diameter mm φ 钩直径	Thickness mm 厚度	Weight g 重量
F-310-S	Rp ≤ 1 × 10 ⁸	180 (W) × 135 (L)	7	1.5	60
F-310-M		330 (W) × 220 (L)		2	230
F-310-L		450 (W) × 330 (L)		460	

- The ground cord is not provided as an accessory. It can be ordered separately.
- 不配接地线。请其它途径购买F-24。



F-315
ESD PAD
防静电小尺寸垫

ESD standard 防静电管理值	External dimensions m 外形尺寸	Hook diameter mm φ 钩直径	Thickness mm 厚度	Weight g 重量
Rp ≤ 1 × 10 ⁸	180 (W) × 135 (L)	7	1.5	60

- The ground cord is not provided as an accessory. It can be ordered separately.
- 不配接地线。请其它途径购买F-24。

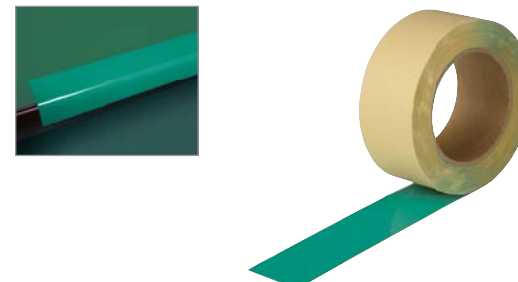

F-750
ESD RUBBER TAPE
防静电胶带

Width m 宽度	Length m 长度	Thickness mm 厚度	Weight g 重量	ESD standard 防静电管理值	Material 材质
50	10	0.5	500	Rg ≤ 1 × 10 ⁹	NBR



F-166
COMMON POINT BENCH GROUND
接地端子

外形寸法	42(W) × 20(H) × 88(D)mm
接続端子	4口(ネジ径M4)
重量	40g

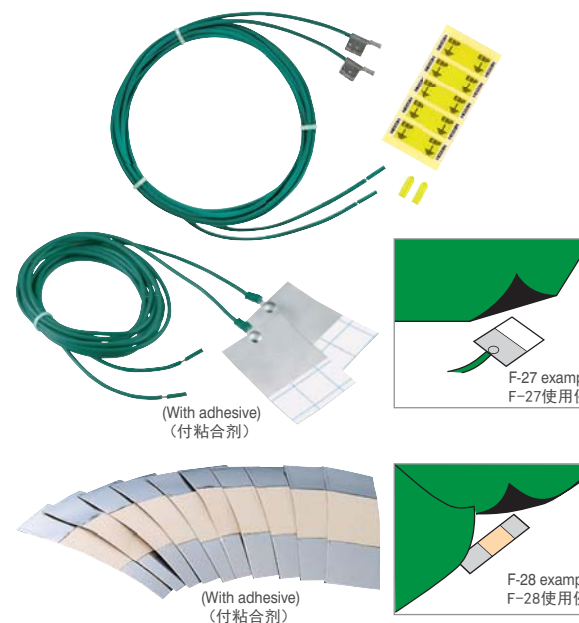

F-127
GROUND CORD
接地线

Wire dia. × length 线径 × 长度	Quantity 内装
1.25 mm ² × 2 m	2-piece pack 2本

F-27
GROUND CORD
接地线

Wire dia. × length 线径 × 长度	Quantity 内装
2 mm ² × 2 m	2-piece pack 2组

- For conductive (ESD) rubber mat
- 用于彩色防静电胶垫

F-28
GROUND PLATE
接地板

Quantity 内装
10-piece pack 10片

- For conductive rubber mat
- 用于彩色防静电胶垫

Equipment for visualizing electrostatic discharge
For several years with no power supply,
Record traces of electrostatic discharge

可视化静电放电设备几年没有电力供应，
记录静电放电痕迹



Industry first !!
Patented
行业第一！
专利

F-240/F-241
ESD VISIBLE CHECKER



By installing it in the ground wiring, it shows that static electricity has passed through the earth wire.
You can check the work and process where static electricity is likely to occur with "visual inspection".
If a defect due to static electricity occurs, it becomes a clue to locate the cause.
The display does not require any power supply, and the display is maintained for several years.

※ F-245 is required to return the display.

ESD可见检查器

通过将其安装在接地线上，表明静电已通过接地线。
“视觉检查”可以检查可能发生静电的工作和过程。
如果出现由静电引起的缺陷，它将成为找出原因的线索。
显示器不需要任何电源，并且显示器保持数年。

※F-245需要返回显示。

Part no. 型号	External dimensions 外形尺寸 m	Electrostatic reaction voltage V 静电反应电压	Internal resistance Ω 内阻	Lead 导线 Size	Weight g 重量	Quantity 数量
F-240	53 (W) ×105 (H) ×9 (D)	HBM 1000 or more HBM 1000以上	Less than 1 M 少于1 M	Size 1.25 mm ² × Length 100 mm 尺寸1.25mm ² ×长度100mm	20	1
F-241					200	10

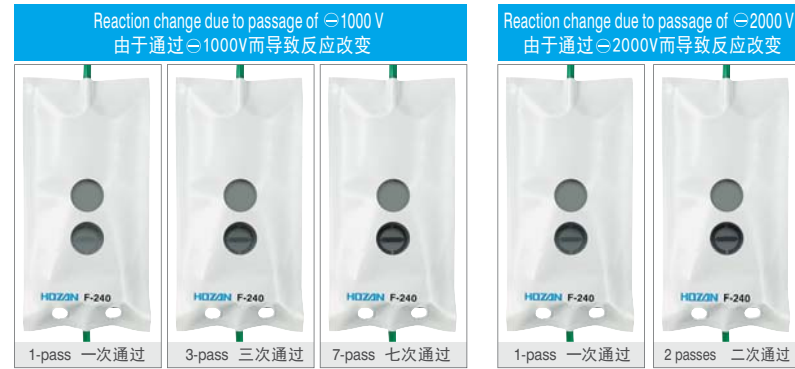

When static electricity flows to the ground wire, display begins to appear.
The larger the static electric charge is, the clearer the display becomes.
The picture shows the state where the charge of [-] has passed.
当静电流到地线时，检查器开始显示。
静电电荷越大，显示器就越清晰。
图片显示[-]的电荷已经过去的状态。

F-245
RESET KEY



Reset the screen display of F - 240.

复位键

重置F-240的屏幕显示。

Power supply 电源	External dimensions 外形尺寸 m	Weight g 重量
With lamination (6F22) battery × 1 使用层压 (6F22) 电池×1	67 (W) ×92 (H) ×28 (D)	150



The administrator resets the display with the dedicated reset key.
管理员使用专用重置键重置显示器。

If you set up a ground line marker 如果你设置了一个地线标记

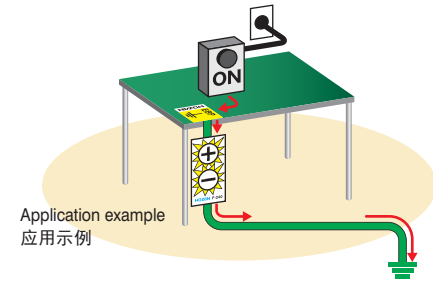
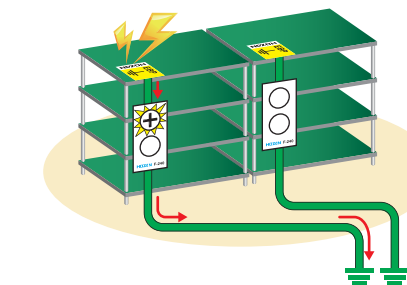
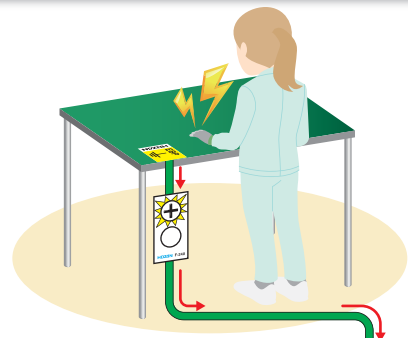

Confirm static electricity flowing to earth
确认流向接地的静电
Static electricity flowing to the ground wire remains on the display. You can check the actual condition of static electricity at a glance. 流向地线的静电仍保留在显示屏上。您可以一目了然地查看静电的实际情况。

Identification of static electricity generation location
静电发生位置的识别
Static electricity flowing from the workbench, storage shelf, etc. will remain as indication. When a defect occurs, you can lead to actions such as exploring the cause centering around the display location. 从工作台、储存架等流出的静电仍将作为表示。发生缺陷时，您可以执行诸如在显示位置周围探索原因的操作。

Detect electric leakage in electrical equipment
检测电气设备的漏电
Electric leakage occurs due to defective ground connection of the electrical equipment and it appears on the display even when it flows to the ground for ESD protection. 由于电气设备的接地故障而导致漏电，即使流入地面以进行静电地面，它也会出现在显示屏上。

Standard type
标准类型



Allergic to metal allergy
对金属过敏敏感



High endurance metal type
高耐力金属类型



To those concerned about the wrist strap code
给那些关心腕带代码的人



Indications 显示			Accuracy 精度	Power supply 电源	Battery life 电池寿命	External dimensions mm 外形尺寸	Weight g 重量
LOW	GOOD	HIGH					
Wrist strap ≤ 750 kΩ 防静电手腕带 ≤ 750kΩ	750 kΩ < wrist strap < 9 MΩ 750kΩ < 防静电手腕带 < 9MΩ	9 MΩ ≤ wrist strap 9MΩ ≤ 防静电手腕带	750 KΩ ... -0%, + 6% 9 MΩ ... -6%, + 0%	With lamination (6F22) battery × 1 使用层压 (6F22) 电池×1	15,000 times or more 1万5千回以上	76 (W) ×35 (H) ×135 (D)	285

F-153
WRIST STRAP
防静电手腕带



F-152
WRIST STRAP
防静电手腕带



F-155
WRIST STRAP
防静电手腕带



F-142
ANKLE STRAP
防静电脚腕带



Part no. 型号	Code total length m 代码总长度	Effective cord length m 线长	Plug diameter mmφ 插头直径	Hook diameter mmφ 夹子直径	ESD standard 防静电管理值	Weight g 重量
F-153						40
F-152	3.1	1.6	4	7	7.5×10 ⁵ ≤ Rg < 3.5×10 ⁷ * Being worn.	40
F-155					※配戴状态	65
F-142	1.6	—	—	—		50

■ With 1 MW resistor
■ 1MΩ电阻值

F-206
WRIST STRAP CHECKER
腕带监测器

F-206-TA
WRIST STRAP CHECKER (with calibration certificate)
腕带监测器(附校正证明书)

* Because the certificate will bear the purchaser's name (company name, etc.), your name is required when ordering.
※因为购买者的名字要入证明书、所以下单时注明公司名是很有必要的。



Anti-static clothing that can cover from sleeves to fuselage and thigh only with outerwear
防静电服装可以覆盖从袖到躯干和大腿



F-190-M/L
ESD PROTECTING GOWN



Apron type which is easy to remove and detach only in coat. Regardless of gender, it corresponds to a wide range of sizes with one sheet. A hook is attached to the abdomen, and it can be used as a garment with a groundable connection point.

防静电连袖围裙

只能在外套上容易穿脱的围裙类型。无论性别如何，它也可以对应各种尺寸。因为在腹部有按扣，所以它可以作为有可接地连接点的服装。

Part no. 型号	Width cm 服装的宽度	Length cm 长	ESD standard 防静电管理值	Hook diameter mmφ 夹子直径	Material 材料	Weight g 重量
F-190-M	56	80	1×10 ⁵ ≤ Rp < 1×10 ¹¹	7	Polyester 聚酯纤维	250
F-190-L	62	88				300

■ Earth wire is not included. Please purchase F-24 separately.
■ 不包括地线。请单独购买F-24。



Escape static electricity from the human body to the floor from shoes, strap suitable for standing work
从鞋子上将人体防静电传到地板上，适合站立工作的表带



F-145
HEEL STRAP



A type strap that wears from the top of the shoe and releases static electricity from the heel to the floor. Just by mounting it on work shoes you get the same effect as electrostatic shoes. (It can also be used for safety shoes)
※ It assumes wearing with both feet.

防静电脚筋带

从鞋的顶部穿着并从脚跟释放防静电到地板的类型表带。只需将它安装在工作鞋上即可获得与防静电鞋相同的效果。(它也可以用于安全鞋)
※穿双脚是先决条件。

Size 尺寸	ESD standard 防静电管理值	Weight g 重量
Free 自由 (Wearing state) (佩戴状态)	7.5×10 ⁵ ≤ Rg < 3.5×10 ⁷	35

■ Resistance of 1 MΩ
■ 1MΩ的电阻

Antistatic floor
防静电地板

I will dissipate static electricity from the heel to the floor.
我会将脚跟的防静电耗散到地面。

Put the ground ribbon on the sole and put on your shoes.
把地带给放在鞋底上，然后穿上鞋子。

Terminal for safely and reliably connecting the wrist strap to the ground
Corresponds to electrostatic discharge protection standard (RCJS)

终端安全可靠地将腕带连接到地面
符合防静电放电保护标准 (RCJS)



F-126
COMMON POINT BENCH GROUND

Up to two wrist straps can be used simultaneously. Common diameter about 4 mm φ Banana plug, you can connect regardless of type. Because it is a type installed under the workbench, it does not affect work space. It conforms to the specification of EBP (ground connection point) for the wrist strap required by each standard.

接地端子

最多可以同时使用两个手腕带。常见的直径约4毫米φ香蕉插头，可以连接，无论类型。因为它是安装在工作台下的类型，所以不会影响工作空间。它符合每个标准所要求的腕带的EBP（接地点）规格。

External dimensions mm 外形尺寸	Connection terminal 连接终端
64 (W) × 39 (H) × 38 (D)	2 mouth for wrist strap (4 mmφ) 2个手腕带 (4 mm)

■ Cord length: 2 m
■ 2 mounting screws included
※ 1 MΩ resistance is not included.
■ 电线长度: 2米
■ 包括2个安装螺丝
※ 不包括1MΩ电阻。

Fitting to pinch a washer of several millimeters in size
适合捏几毫米大小的垫圈

Outstanding breathability of the striking structure
由于手背的结构



10 pair provided
10双入

F-66-S/M/L
ESD GLOVES



Excellent grip power is realized with fingertip PU coat. You can operate tablets and smartphones.

■ 10 pair provided

防静电手套

用指尖PU涂层实现出色的握力。您可以操作平板电脑和智能手机。
■10双入



F-61-M/L
ESD GLOVES



No coat. We are knitted with only the entire conductive fiber. Seamless stereoscopic finish, excellent in elasticity, there is no fatigue feeling even for long hours work. It is excellent in breathability, and it is difficult to muffle even when used for a long time. You can also operate tablets and smartphones smoothly. Equivalent to class 1000.

■ 1 pair provided

防静电手套

没有涂层。全部只用防静电纤维编而成。无缝立体饰面，弹性极佳，即使长时间工作也没有疲劳感。透气性优异，即使长时间使用也难以闷热。您还可以顺利操作平板电脑和智能手机。相当于1000级。
■1双入



F-64-S/M/L
ESD GLOVES



Palm full face coat. Ultra thin backpacking structure ensures breathability. While thin, highly durable specification that can be used repeatedly washing more than 30 times. Excellent surface smoothness, touch tablets and smartphones can be operated smoothly. Equivalent to class 1000.

■ 1 pair provided

防静电手套

掌上的全掌有PU涂层。手背的结构确保透气性。虽然超薄耐用的规格可反复使用30次以上。您还可以顺利操作平板电脑和智能手机。相当于1000级。
■1双入



Part no. 型号	Size 尺寸	OAL mm 全长	ESD standard 防静电管理值	Weight g 重量	Color (Wrist portion) 颜色 (手腕部分)
F-66-S	S	190	Charge decay from 1000 V to 100 V in less than 2 secs. 电荷从1000V至100V衰减时间不到2秒	15	White 白
F-66-M	M	205		16	Green 绿
F-66-L	L	220		16	Gray 灰
F-61-L	M	195		15	White 白
F-61-L	L	205		16	Black 黑
F-64-S	S			12	Orange 橙
F-64-M	M			14	Green 绿
F-64-L	L	225		15	White 白

※Dimensions may fluctuate somewhat for cloth products.
※由于是纤维产品尺寸存在少许误差。

Performance evaluation of anti-static products can be easily done
Corresponds to ESD protection standards (RCJS, JIS, IEC, ANSI)

防静电产品的性能评估可以轻易完成
符合防静电保护标准 (RCJS, JIS, IEC, ANSI)



F-109 SURFACE RESISTANCE CHECKER

It is a measuring instrument for measuring the resistance value of anti-static products. Special electrode corresponding to the standard, light weight soft case with convenience for carrying and storage. It has two kinds of mode switching function. (20 seconds, 35 seconds off mode switching type) In the 20 second off mode, hold the measured value at measurement time (after 15 seconds) specified by the standard.

表面电阻计

它是测量防静电产品电阻值的测量仪器。特殊电极对应标准，重量轻的软盒，便于携带和存放。两种模式切换功能。（20秒，35秒关闭模式切换类型）在20秒关闭模式下，在标准规定的测量时间（15秒后）保持测量值。

Measurement range 测定范围	9.00 × 10 ² Ω or more 2.00 × 10 ¹² Ω or less 9.00×10 ² Ω以上 2.00×10 ¹² Ω以下
Applied voltage 施加电压	When the object is less than 1.00 × 10 ⁶ Ω ... 10 V When the object is 1.00 × 10 ⁶ Ω or more ... 100 V 当物体小于1.00×10 ⁶ Ω...10V时 当物体大于1.00×10 ⁶ Ω或更大...100V时
Accuracy 精度	± 10% (However, for 1.00 × 10 ¹¹ Ω or more, ± 20%) ± 10% (但是, 对于1.00×10 ¹¹ Ω或更多, ±20%)
Power supply 电源	With lamination (6LR61 / 6LF22) battery × 1 使用层压 (6LR61 / 6LF22) 电池×1
Battery life 电池寿命	1000 times or more (35 seconds off mode) 1000次或更多 (35秒关闭模式)
Dimensions 外形尺寸	Body 本体 85 (W) × 40 (H) × 170 (D) mm (not including protrusions) (不包括突起) Electrode 电极 79 mm φ × 110mm Case 便携箱 290 (W) × 170 (H) × 130 (D) mm
Gross weight 重量	5.1 kg Body: 300 g (battery not included) (不包括电池), Electrode 电极: 2.3 kg (1 piece) (1个)

- With auto power off function
- Two electrodes, two connecting cords (1.5 m), a ground wire, two alligator clips, a cloth scale (40 cm), with a carrying case
- 带自动断电功能
- 标配鳄鱼夹2个、连接线2本、便携箱

F-109-TA SURFACE RESISTANCE CHECKER (with calibration certificate)

表面电阻计(附校正证明书)

* Because the certificate will bear the purchaser's name (company name, etc.), your name is required when ordering.
※因为购买者的名字要入证明书,所以下单时注明公司名是很有必要的。

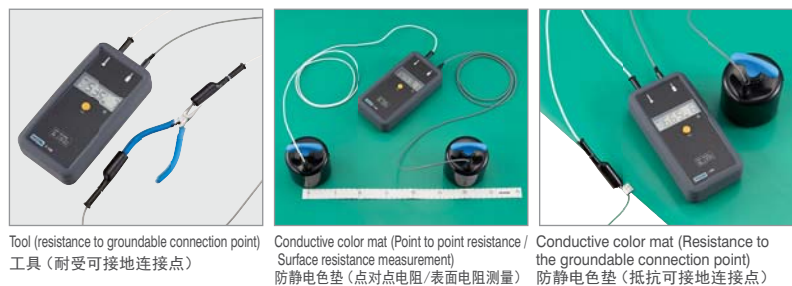

Tool (resistance to groundable connection point) 工具(耐受可接地连接点)
Conductive color mat (Point to point resistance / Surface resistance measurement) 防静电色垫(点对点电阻/表面电阻测量)
Conductive color mat (Resistance to the groundable connection point) 防静电色垫(抵抗可接地连接点)

F-109-1 SURFACE RESISTANCE CHECKER (Without electrode)

The body of F-109. Depending on the object to be measured, an optional electrode is required.

表面电阻计(不含电极)

F-109的机体。根据要测量的物体,需要一个可选电极。

Dimensions 外形尺寸	85 (W) × 40 (H) × 170 (D) mm (not including protrusions) (不包括突起)
Weight 重量	300 g (battery not included) (不含电池)

- With auto power off function
- Two connection cords (1.5 m), with a grounding wire, two alligator clips
- 带自动断电功能
- 两根连接线(1.5m),带有接地线,两个鳄鱼夹

F-109-1-TA SURFACE RESISTANCE CHECKER (Without electrode / with calibration certificate)

表面电阻计(不含电极·附校正证明书)

* Because the certificate will bear the purchaser's name (company name, etc.), your name is required when ordering.
※因为购买者的名字要入证明书,所以下单时注明公司名是很有必要的。

Replacement parts 更换部件

F-101 ELECTRODES (2.3 kg)
Quantity : 2
Dimensions : 79 mm φ × 110 mm
Weight : 2.3 kg (1 piece)

电极 (2.3kg)
装入数 : 2
外形尺寸 : 79mm φ × 110mm
重量 : 2.3kg (1个)

F-101-TA ELECTRODES (2.3kg with calibration certificate)
电极 (2.3kg 附校正证明书)

* Because the certificate will bear the purchaser's name (company name, etc.), your name is required when ordering.
※因为购买者的名字要入证明书,所以下单时注明公司名是很有必要的。



Optional parts 选购配件

F-102 ELECTRODES (For footwear)
By combining with F-109, it is possible to measure the resistance of ESD footwear.
Dimensions : Footwear electrode 300 (W) × 19 (H) × 300 (D) mm
Finger electrode 35 mm φ × 30 mm
Weight : 1.3 kg
With extension code

电极(对于鞋类)
通过与F-109相结合,可以测量防静电鞋的阻力。
外形尺寸 : 鞋类电极 300 (W) × 19 (H) × 300 (D) mm
指状电极 35mm φ × 30mm
重量 : 1.3kg
使用扩展代码



F-103 ELECTRODES (For clothing)
By combining with F-109, it is possible to measure the resistance value of anti-static clothing. Simply hold the clothing with the electrode and you can easily measure it.
Dimensions : Electrodes 450 (W) × 50 (H) × 230 (D) mm
(Excluding protrusions)
Chain 1 m
Weight : 600 g

电极(对于服装)
通过与F-109相结合,可以测量防静电服装的阻力值。只需用电极握住衣服,即可轻易测量。
外形尺寸 : 电极 450 (W) × 50 (H) × 230 (D) mm (排除突起)
链 1m
重量 : 600g



F-109-4 ELECTRODES
By combining with F - 109, it is an electrode that can measure resistivity simply. Ideal for daily inspections done during periodic inspections. ※ Please be sure to use the electrode attached to F-109 for measurement according to the standard.
Dimensions : 62 (W) × 68 (H) × 15 (D) mm
Weight : 80 g
Cord length : 15 cm
With rubber band

电极
通过与F-109相结合,它可以简单地测量阻力值。非常适合在定期检查中进行日常检查。※按照标准进行测量时,请务必使用连接到F-109的电极。
外形尺寸 : 62 (W) × 68 (H) × 15 (D) mm
重量 : 80g
线长 : 15cm
用橡皮带



Simple measurement can be easily done with one hand
简单的测量可以用一只手轻易完成

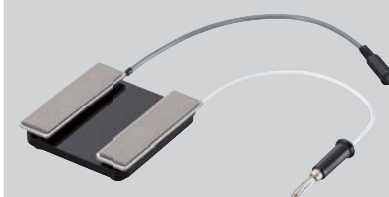

Attached to F-109 with attached band
连接带F-109

F-104 INSULATION SHEET
Insulation sheet that shuts off electrical connection. By laying under the object to be measured, more accurate measurement can be performed. With a compact storage case.
Insulation performance : Point resistance 2 × 10¹² Ω ≤ Rp
Dimensions : 1000 (W) × 800 (H) mm
Weight : 400 g

绝缘片
关闭电气连接的绝缘片。通过铺设在待测物体下方,可以进行更精确的测量。带紧凑的存储箱。

绝缘性能 : 点电阻 2 × 10¹² Ω ≤ Rp
外形尺寸 : 1000 (W) × 800 (H) mm
重量 : 400g



For measuring static electricity countermeasures
用于测量防静电对策

	Connection environment 连接环境	Number of effective pixels 有效像素数	Maximum frame rate 最大帧速率	Save 保存	Other functions 其他功能	Microscope lineup 显微镜阵容
L-851 FULL HD CAMERA HDMI工业相机 No personal computer required Camera that can observe with full HD image quality, save images and movies 不需要个人电脑 可以观看全高清图像质量的相机, 保存图像和视频 P.37		CMOS 2 million 200万	60 fps			 L-KIT580 L-KIT585 L-KIT603 32 items 32型号
L-850-1 FULL HD CAMERA (No lens · HDMI connection) HDMI工业相机 (无镜头·HDMI连接) Can inspect and work with full HD picture quality without PC 无需PC即可检查和使用全高清图像质量 P.39		CMOS 2 million 200万	60 fps		 <small>Only when using L-850-2 只有在使用L-850-2</small>	 L-KIT518 L-KIT523 L-KIT534 19 items 19型号
L-835 USB CAMERA USB工业相机 5 megapixel high quality USB camera with excellent cost performance 500万像素高品质USB相机, 具有出色的性价比 P.41		CMOS 5 million 500万	30 fps		 <small>Please use multiple windows by downloading compatible software from the web. 请从网上下载多窗口软件并使用它</small>	 L-KIT500 L-KIT505 L-KIT516 27 items 27型号
L-860 MICROSCOPE CAMERA WITH DISPLAY 一体机 Full HD monitor and camera integrated All-in-one camera unnecessary for personal computers 全高清显示器和相机集成 个人电脑不需要一体式相机 P.43		CMOS 2 million 200万	30 fps			 L-KIT548 L-KIT563 L-KIT565 23 items 23型号

Stereoscopic microscope lineup 体视显微镜阵容

Fixed magnification formula 固定放大类型

L-50 base L-50基本 P.49

10 items
10型号

L-50 L-KIT537 L-KIT540

L-51 base L-51基本 P.50

11 items
11型号

L-51 L-KIT543

Zoom type 缩放类型

L-46 base L-46基本 P.51

12 items
12型号

L-46 L-KIT619 L-KIT624

No personal computer required
Camera that can observe with full HD image quality,
save images and movies

不需要个人电脑,可以观看全高清图像质量的相机,保存图像和视频

32
items
型号



FULL HD CAMERA SYSTEM (for monitor)
HDMI工业相机

HDMI **Monitor 显示器** **CMOS 2 million 200万** **60 fps** **Image / Movie 图像/视频 Save 保存**

Digital zoom 数字变焦 **Monochrome 单色** **Line marker 线标记** **Image reversal 图像反转** **Interval video 间隔录影** **Self-timer shooting 自拍拍摄** **3 Sequential shooting 三连拍**

Image pickup device 传感器尺寸	1 / 2.8 *CMOS image sensor CMOS图像传感器
Output connector 支持接口	HDMI
Number of effective pixels (maximum) 有效像素 (最大)	1920 x 1080 (2 million pixels) (200万像素)
Number of stored pixels (maximum) 保存分辨率 (最大)	Still image 1920 x 1080 (2 million pixels) 静止图像 1920x1080 (200万像素) Video 1920 x 1080 (2 million pixels) / 1280 x 720 (900,000 pixels) 视频 1920x1080 (200万像素) / 1280x720 (90万像素)
Recording file format 记录格式	Still image JPG 静止图像 JPG Video MOV 视频 MOV
Recording media 存储媒体	microSD / SDHC / SDXC memory card (maximum 128GB) 存储卡 (最大128GB)
Frame rate 帧速率	Maximum 60 fps 最大60 fps
Lens mount 镜头接口	C mount
Display language 语言设置	Japanese, English, Chinese (simplified, traditional) 日语, 英语, 中文 (简体, 繁体)
Power supply 电源	DC 5 V (with AC Adapter) * Power supply via USB connection is also possible. (带交流适配器)*也可以通过USB连接供电。
Power consumption 耗散功率	2.5W
Dimensions 外观尺寸	50 (W) x 50 (H) x 48 (D) mm (excluding projections) (不包括投影)
Weight 单机重量	Body 163 g (excluding accessories) 本体 163g (不含配件) Remote controller 60 g 遥控器 60g

L-859 DISPLAY MONITOR
Size: 11.6 inches
显示器
尺寸: 11.6英寸

P.45

Camera operation 相机操作

You can operate with the operation button on the back of the camera body.
您可以使用相机机身背面的操作按钮进行操作。

If you use the supplied remote control you can operate from a remote place, you can use it stably even at high magnification.
如果您使用附带的遥控器,您可以在偏远的地方进行操作,即使在高倍率下也可以稳定地使用它。

Function 功能

60 fps
It consists of 60 still images per second, and it is a smooth, no afterimage image.
它每秒包含60个静止图像,并且是一个平滑的,无残像的图像。

1 second 1秒

Digital zoom 数字变焦
The image can be scaled up to 1 to 4 times in a stepless manner.
图像可以以无级方式放大1到4倍。

Monochrome 单色
You can erase the color information and observe with only light and dark.
您可以擦除颜色信息并只用明暗观察。

Image / Movie 图像/视频 Save 保存
Line marker 线标记
Self-timer shooting 自拍拍摄
3 Sequential shooting 三连拍
Interval video 间隔录影

HOZAN Image Editor <http://www.hozan.co.jp/>

We prepare software that can edit saved images with PC. Dimension measurement is also possible.
我们准备可以用PC编辑保存的图像的软件。尺寸测量也是可能的。

Free download available 可免费下载

26x ←→ 190x

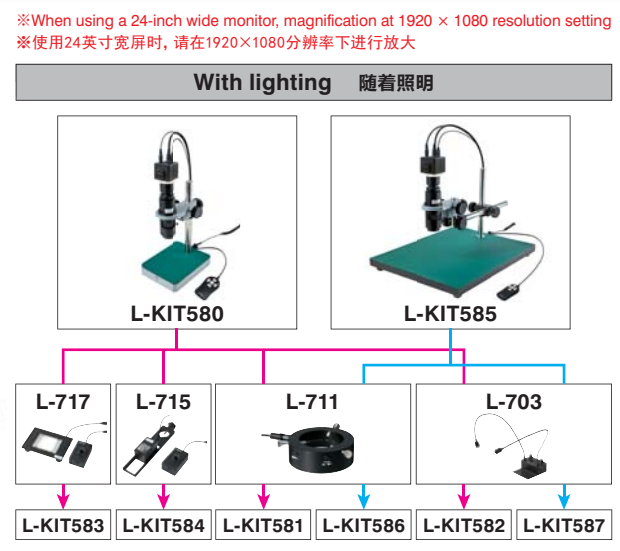

53x ←→ 380x

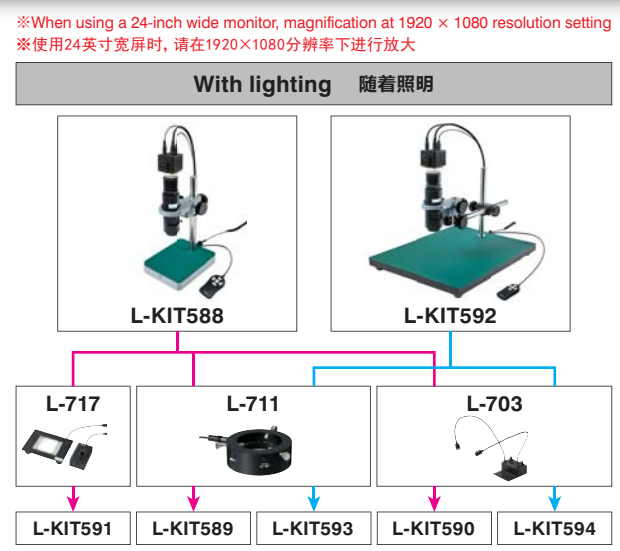

18 / 44 / 88 / 110x



※ When using a 24-inch wide monitor, magnification at 1920 x 1080 resolution setting
※ 使用24英寸宽屏时,请在1920x1080分辨率下进行放大



※ When using a 24-inch wide monitor, magnification at 1920 x 1080 resolution setting
※ 使用24英寸宽屏时,请在1920x1080分辨率下进行放大



※ When using a 24-inch wide monitor, magnification at 1920 x 1080 resolution setting
※ 使用24英寸宽屏时,请在1920x1080分辨率下进行放大

Can inspect and work with full HD picture quality without PC

无需PC即可检查和使用全高清图像质量

19 items 型号



FULL HD CAMERA SYSTEM (for monitor)
HDMI工业相机

HDMI

Monitor 显示器

CMOS 2 million 200万

60 fps

MINI Smallest and lightest 最小, 最轻

Shadow mask 障板 Only when using L-850-2 只有在使用L-850-2

Line marker 线标记 Only when using L-850-2 只有在使用L-850-2

Image reversal 图像反转 Only when using L-850-2 只有在使用L-850-2

Image pickup device	传感器尺寸	1 / 2.8 "CMOS image sensor	"CMOS图像传感器
Output connector	支持接口	HDMI	
Number of effective pixels	有效像素	1920 × 1080 (2 million pixels)	(200万像素)
Video output	视频输出	Compliant with DVI 1.0 DVI 1.0	RGB, 1080P60 RGB, 1080
frame rate	帧速率	Maximum 60 fps	最大60 fps
Lens mount	镜头接口	C mount	
Power supply	电源	DC 12 V (with AC adapter)	(带AC适配器)
power consumption	功耗功率	4.4 W	
Dimensions 外观尺寸	L-850	φ55 x 78 mm (excluding protrusions)	(不包括突起)
	L-850-1	φ55 x 86.5 mm (when L-818 is installed)	(安装L-818时)
Weight 单机重量	L-850	228 g (excluding accessories)	(不含配件)
	L-850-1	116 g	

L-859 DISPLAY MONITOR

Size: 11.6 inches
显示器
尺寸: 11.6英寸

P45

L-850-2 OSD CONTROLLER
相机控制器

Detailed setting of the camera is possible on the monitor
显示器上可能有相机的详细设置



Maximum frame rate 60 fps 最大帧速率60 fps

60 fps

It consists of 60 still images per second, and it is a smooth, no afterimage image.
它每秒包含60个静止图像, 并且是一个平滑的, 无残像的图像。

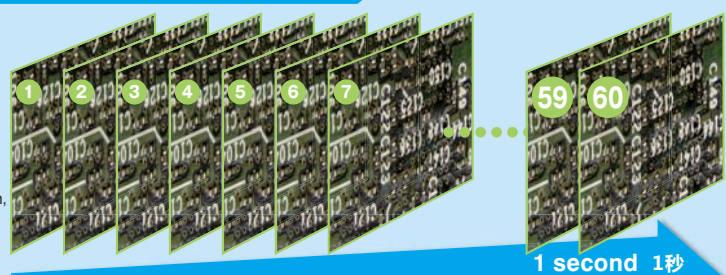

L-808-3 M4 SCREW ADAPTER

Adapter to convert camera mounting screw (1/4" × 20 mountain) to M4 screw.

螺丝适配器
将相机安装螺丝 (1/4" × 20山) 转换为M4螺丝的适配器。

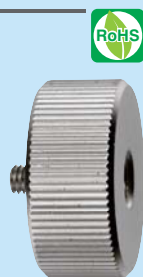

Camera controller usage example 相机控制器使用示例

Line marker 线标记
Vertical and horizontal lines can be displayed on the display screen.
垂直线和水平线可以显示在显示屏上。

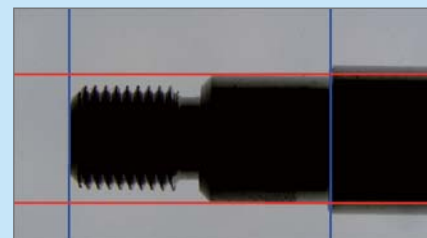

Shadow mask 阴影面具
When you want to inspect only a specific place
当您只想检查一个特定的地方

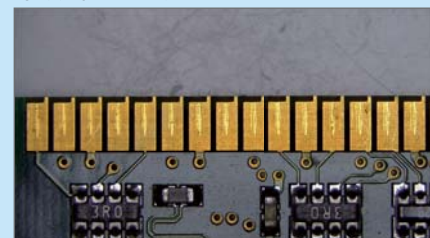

You can limit the range of the display screen.
您可以限制显示屏的范围。



27 × ← → 195 ×

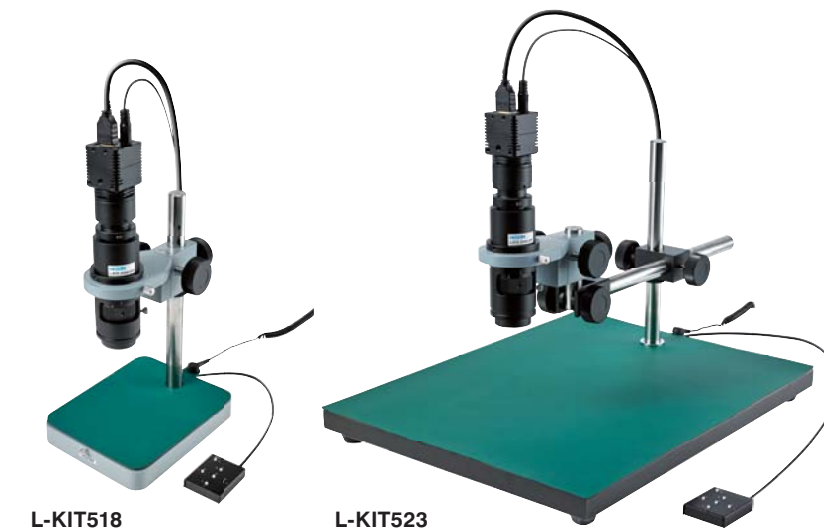

※When using a 24-inch wide monitor, magnification at 1920 × 1080 resolution setting
※使用24英寸宽屏时, 请在1920×1080分辨率下进行放大

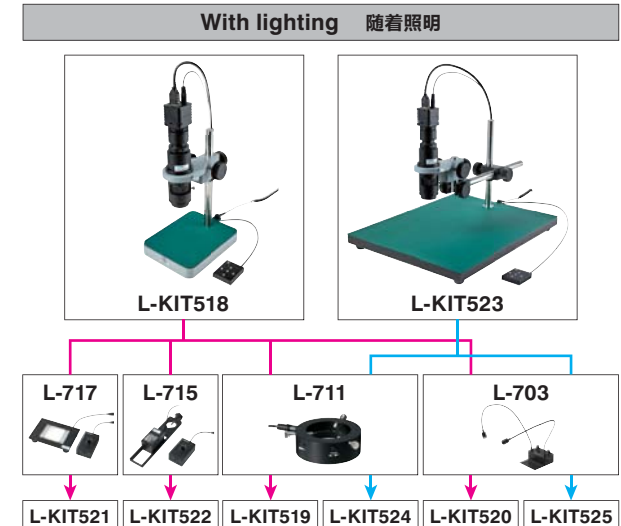

18 / 45 / 91 / 115 ×

18 / 45 ×

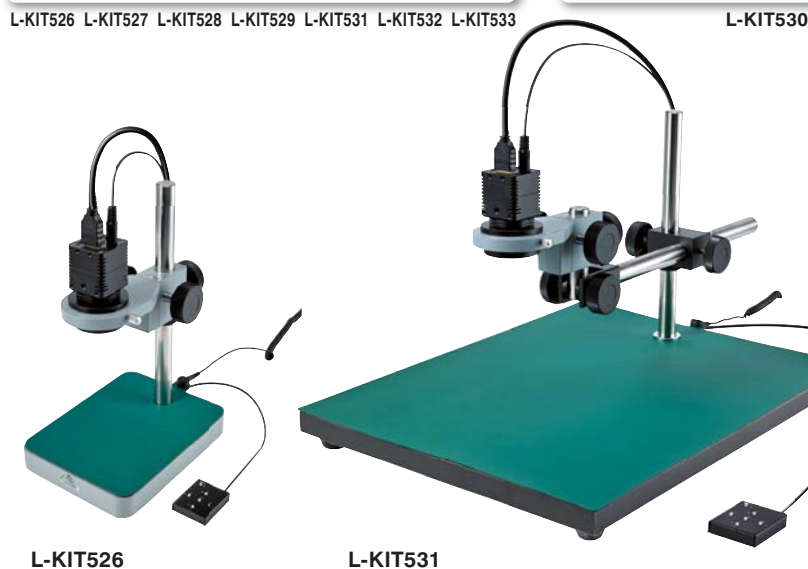

※When using a 24-inch wide monitor, magnification at 1920 × 1080 resolution setting
※使用24英寸宽屏时, 请在1920×1080分辨率下进行放大

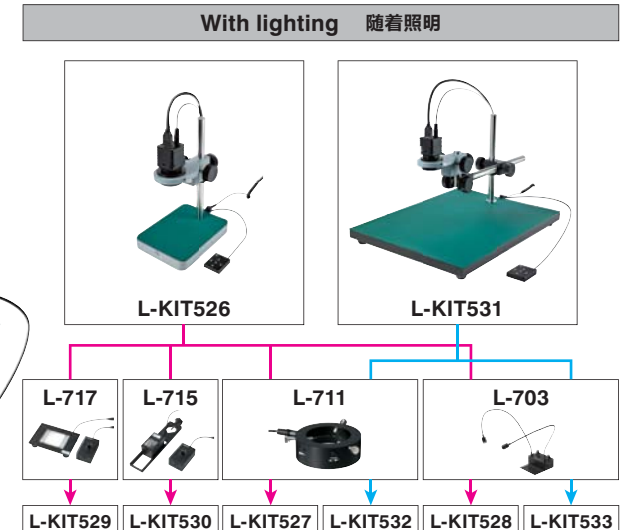

9.2 / 18 ×

2.9 ← → 11 ×

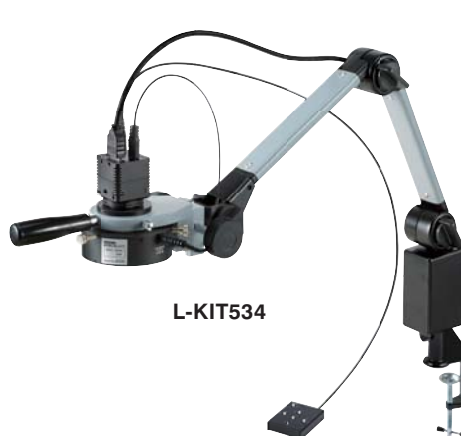

8.6 ← → 13 ×



※ When using a 24-inch wide monitor, magnification at 1920 × 1080 resolution setting
※ 使用24英寸宽屏时, 请在1920×1080分辨率下进行放大

※ When using a 24-inch wide monitor, magnification at 1920 × 1080 resolution setting
※ 使用24英寸宽屏时, 请在1920×1080分辨率下进行放大

※ When using a 24-inch wide monitor, magnification at 1920 × 1080 resolution setting
※ 使用24英寸宽屏时, 请在1920×1080分辨率下进行放大

5 megapixel high quality USB camera with excellent cost performance

500万像素高品质USB相机, 具有出色的性价比

27 items 型号



USB CAMERA SYSTEM (for PC) USB工业相机

Please use multiple windows by downloading compatible software from the web. 请从网上下载多窗口软件并使用它

Image pickup device 传感器尺寸	1 / 2.5" CMOS image sensor "CMOS图像传感器"
Output connector 支持接口	USB 2.0
Number of effective pixels (maximum) 有效像素 (最大)	2592 x 1944 (5 million pixels) (500万像素)
Number of stored pixels (maximum) 存储像素 (最大)	Still image 2592 x 1944 (5 million pixels) 静止图像 2592 x 1944 (500万像素) Movie 1280 x 960 (1.2 million pixels) 视频 1280 x 960 (120万像素)
Frame rate 帧速率	Maximum 30 fps, but only when using 5 million pixels 10 fps 最大30 fps, 但仅限于使用500万像素 10 fps
Recording file format 记录格式	Still image JPG / BMP / PNG / PDF 静止图像 JPG / BMP / PNG / PDF Video AVI 视频 AVI
Lens mount 镜头接口	C mount
Power supply 电源	DC 5 V (USB)
Power consumption 耗散功率	0.35 W
Dimensions 外观尺寸	50 (W) x 50 (H) x 46.6 (D) mm (excluding projections) (不包括投影)
Weight 单重	170 g

Operating environment 电脑配置	OS: Windows 10/8/7 / XP * 1 (32 bit and 64 bit) (32bit或64bit) CPU: Intel Core 2 Duo 1.6 GHz or more 以上 Memory: 1 GB or more 内存 1GB以上 Hard disk: Free space of 20 GB or more 硬盘: 20 GB或更多的可用空间 * 700 MB is required to install special software. *700 MB用于软件安装 USB port: USB接口 (USB 2.0)
Software 软件	HOZAN USB cam software (Language: Japanese / English / medium correspondence) Basic functions: preview, still / movie shooting Display function: Digital zoom, image rotation, image reversal Adjustment function: exposure, white balance, frequency, gamma, contrast, Saturation, sharpness, brightness, hue, backlight correction Editing functions: Paint, trimming, text insertion, line insertion Measurement function: distance between two points, distance between plural points, distance between two points of circle, arc length, Angle, 4 point angle, rectangle, polygon, circle, parallel line distance HOZAN USB cam software (语言: 日/英/中) 基本 预览、拍照、视频录像 显示 数字变焦、图像回传、图像反转 调整 曝光补偿、白平衡、频率、亮度、对比、饱和度和、锐度、明度、色调、逆光补偿 编辑 画图、修整、插入字符、插入线 测量 直线测量、折线测量、同心圆测量、圆弧测量、角度测量、夹角测量、矩形测量、多边形测量、圆形测量、平行线距离测量

Shooting function 拍摄功能



Observation 检测
You can easily shoot still images and movies with just one button. Image selection such as resolution selection, brightness and color tone can be done easily while watching the image.
只需一个按钮即可轻易拍摄静态图像和动画。可以在观看图像时轻易完成分辨率选择, 亮度和色调等图像选择。

Edit function 编辑功能

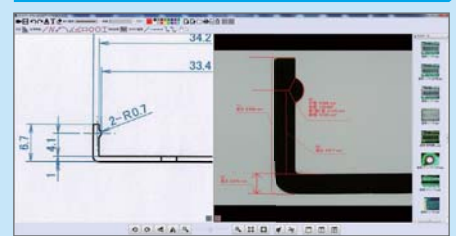

Screen 2 · 4 split 屏幕2·4分割
Multiple images can be displayed / edited. It also supports PDF display, and it widens the range of utilization, such as measuring the inspection object while checking the drawing.
可以显示/编辑多个图像。它还支持PDF显示, 并扩大了使用范围, 例如在检查绘图时测量检查对象。

Video call 视频通话

It can also be used as a camera for video call (Skype etc.) on the Web. It is possible to share diagnostic images in remote areas and in real time.
它也可以用作Web上的视频通话 (Skype等) 的相机。可以在偏远地区和实时共享诊断图像。

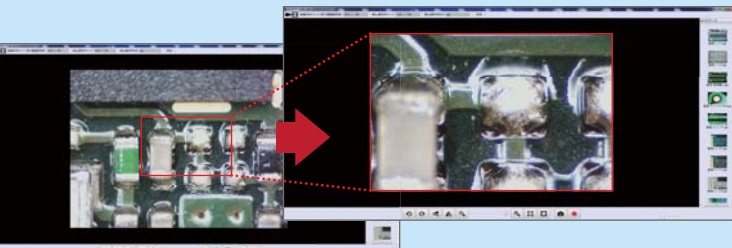

Zoom 放大
You can enlarge or reduce the image on the software with the zoom function. You can also enlarge / reduce during movie shooting.
※It may be unusable depending on the setting of software.
您可以使用缩放功能放大或缩小软件中的图像。您也可以在短片拍摄期间放大/缩小。
※根据软件的设置它可能无法使用。

Measurement function 测量功能



Dimension measurement 尺寸测量
Various measurement functions are included. The result of measurement can be extracted to Word, Excel with one button.
※Measurement function · measurement value · inspection image is displayed. It is also easy to create a report.
包括各种测量功能。测量结果可以通过一个按钮提取到Word, Excel。
※测量功能·测量值·显示检查图像。写报告也很容易。

Free download available 可免费下载 <http://www.hozan.co.jp/>

Multi-window compatible software 多窗口兼容软件
Activate multiple cameras simultaneously 同时激活多台摄像机
It is installed in an automatic crimping machine and the terminal crimping part is examined diversely.
它被安装在一个自动压接机中, 端子压接部分被检查不同

8.7x ↔ 250x



L-KIT500 L-KIT505

※When using a 24-inch wide monitor, magnification at 1920 x 1080 resolution setting
※使用24英寸宽屏时, 请在1920x1080分辨率下进行放大

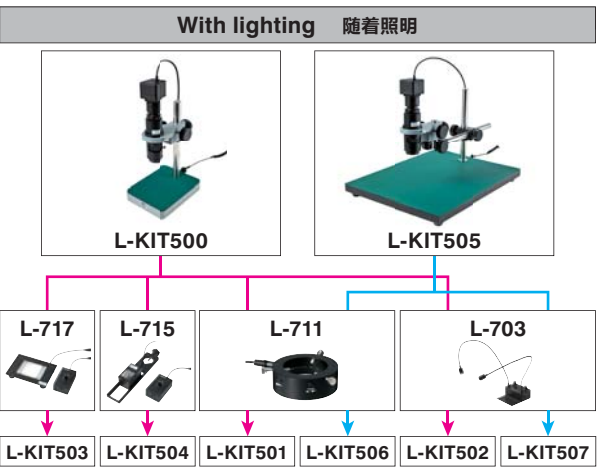

17x ↔ 500x

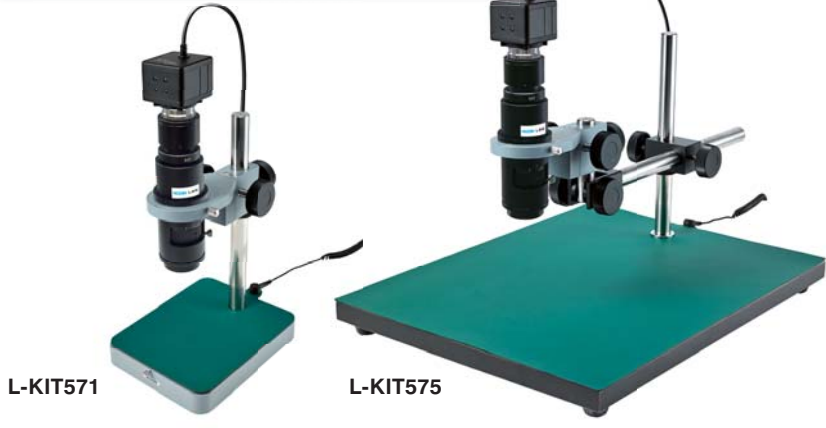

L-KIT571 L-KIT575

※When using a 24-inch wide monitor, magnification at 1920 x 1080 resolution setting
※使用24英寸宽屏时, 请在1920x1080分辨率下进行放大

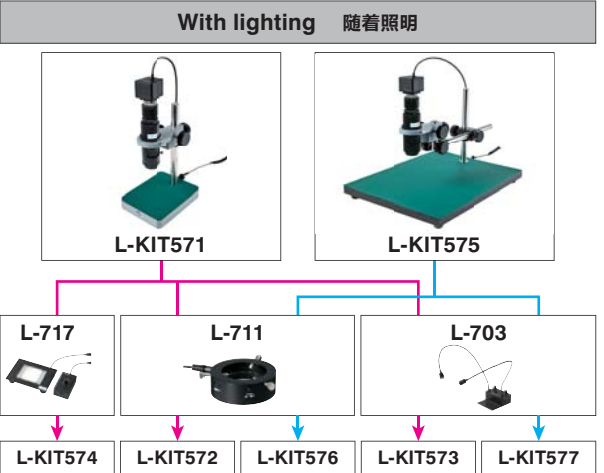

6.0x ↔ 150x



L-KIT508 L-KIT513

※When using a 24-inch wide monitor, magnification at 1920 x 1080 resolution setting
※使用24英寸宽屏时, 请在1920x1080分辨率下进行放大

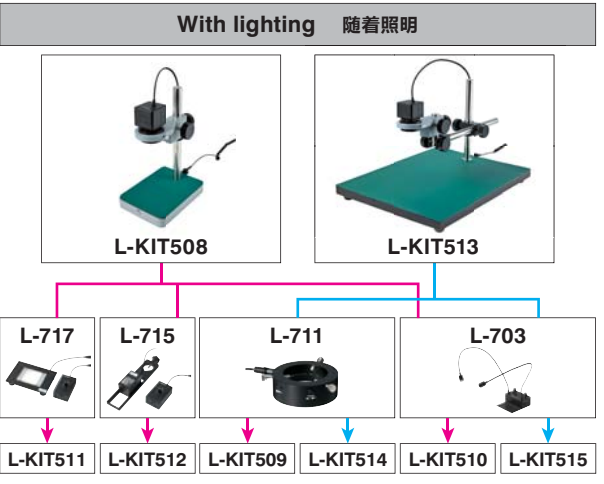

0.9x ↔ 15x



※ When using a 24-inch wide monitor, magnification at 1920 x 1080 resolution setting
※ 使用24英寸宽屏时, 请在1920x1080分辨率下进行放大

2.7x ↔ 17x



※ When using a 24-inch wide monitor, magnification at 1920 x 1080 resolution setting
※ 使用24英寸宽屏时, 请在1920x1080分辨率下进行放大

Full HD monitor and camera integrated
All-in-one camera unnecessary for personal computers
全高清显示器和相机集成 个人电脑不需要一体式相机

23 items 型号



MICROSCOPE CAMERA WITH DISPLAY SYSTEM (for monitor) 一体机

Built in 内置 **CMOS 2 million 200万** **30 fps** **Image / Movie 图像 / 视频 Save 保存**

Digital zoom 数字变焦 **Monochrome 单色** **Line marker 线标记** **Image reversal 图像反转**

Image pickup device 传感器尺寸	1/3" CMOS image sensor	CMOS图像传感器
Number of effective pixels 有效像素	1920 x 1080 (2 million pixels)	(200万像素)
Number of effective pixels 保存分辨率	Still image 1920 x 1080 (2 million pixels) Video 1920 x 1080 (2 million pixels) / 1280 x 720 (900,000 pixels)	静止图像 1920x1080 (200万像素) 视频 1920x1080 (200万像素) / 1280x720 (90万像素)
Recording file format 记录格式	Still image JPG / Video AVI	静止图像 JPG / 视频 AVI
Recording media 存储媒体	SD / SDHC memory card (maximum 32 GB)	SD / SDHC存储卡 (最大32 GB)
frame rate 帧速率	Maximum 30 fps	最大30 fps
Lens mount 镜头接口	C mount	
Monitor 显示器	Glare (gloss) liquid crystal IPS method LCD IPS Size 11.6 wide 尺寸 11.6寸 Resolution 1920 x 1080 (2 million pixels)	最高分辨率 1920x1080 (200万像素)
Software 软件	With dedicated OS Basic functions: preview, still / movie shooting Display function: Digital zoom (1 to 10 times), image reversal, screen fixed, monochrome display, line display, HDR display Adjustment Function: Exposure, White Balance, Frequency, Gamma, Contrast, Saturation, Lightness, Sharpness, Noise Reduction, RGB/RGB	
Power supply 电源	DC 12 V (with AC adapter)	DC 12 V (带AC适配器)
power consumption 耗散功率	7.8W	
Dimensions 外观尺寸	282 (W) x 202 (H) x 62 (D) mm (not including protrusions)	(不包括突起)
Weight 单机重量	710g	

HOZAN Image Editor <http://www.hozan.co.jp/>

We prepare software that can edit saved images with PC. Dimension measurement is also possible.
我们准备可以用PC编辑保存的图像的软件。尺寸测量也是可能的。

Free download available 可免费下载

Preview / shooting / image display is possible 预览·拍摄·图像显示可能

Image comparison 图像比较

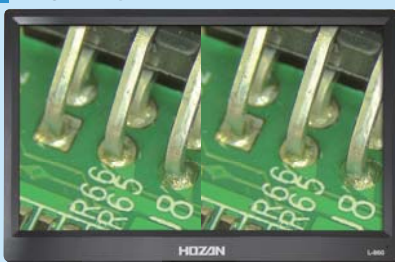

Saved images and images being shot are displayed on two screens. You can take a good sample and use it for comparative inspection etc.
正在拍摄的保存图像和图像显示在两个屏幕上。您可以拿一个好样品，并用它进行比较检查等。

Line indication 线路指示

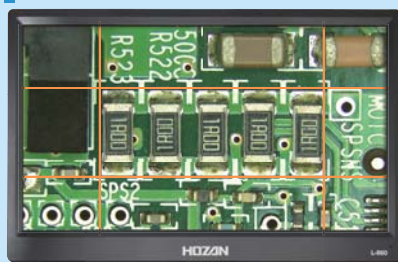

Up to 8 lines can be displayed in each of the vertical and horizontal directions. It is useful for positioning of workpiece etc.
每个垂直和水平方向最多可显示8行。对于工件等的定位很有用。

Image quality adjustment 图像质量调整

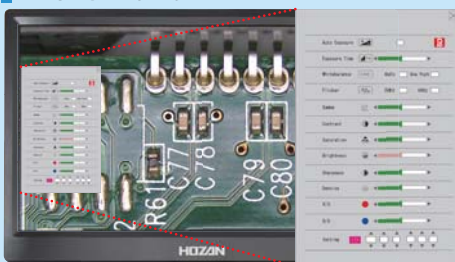

You can easily adjust brightness and color. 您可以轻易调整亮度和颜色。

Digital zoom 数字变焦

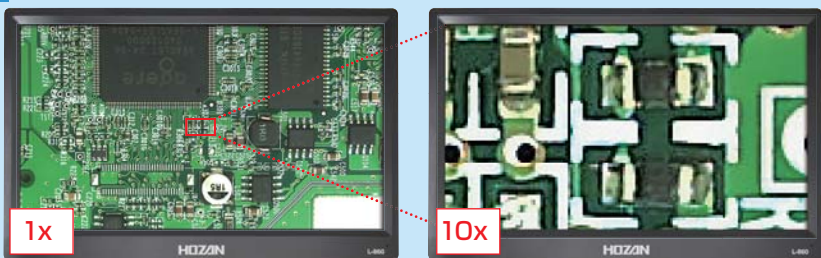

The displayed image can be enlarged / reduced steplessly from 1 to 10 times. ※Valid only at observation. Digital zoom is not applied to still images / movies taken.
显示的图像可以从1到10倍无级放大/缩小。※只在观察时有效。数字变焦不适用于拍摄的静止图像/动画。

HDR (High Dynamic Range) display HDR (高动态范围)显示

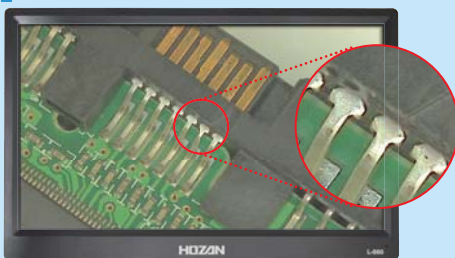

By using the HDR function, you can automatically adjust the balance of bright and dark areas, keep glare and reduce glare. 通过使用HDR功能，您可以自动调节明亮区域的平衡，保持眩光并减少眩光。

13x ↔ 97x



27x ↔ 195x



9.7 / 23 / 46 / 60x



9.7 / 23x

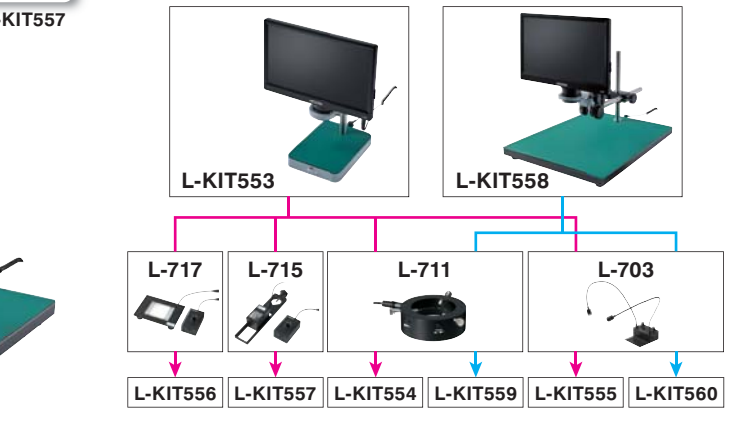

2.2x ↔ 5.8x



2.2x ↔ 5.8x

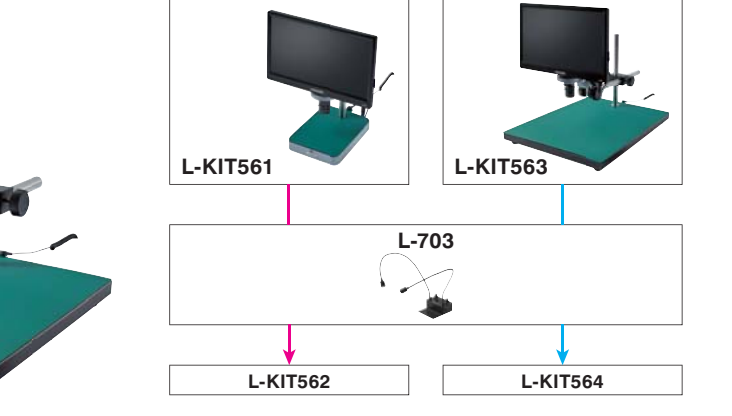

1.0 ↔ 5.8x



3.0 ↔ 6.8x



Small (11.6 inch) full HD monitor with HDMI connection type

带HDMI连接类型的小型(11.6英寸)全高清显示器



※This product does not have image quality adjustment function. Adjustment on the camera side is necessary.
※本产品没有图像质量调节功能。相机侧的调整是必要的。



The table stand can be steplessly adjusted by 180 degrees
台架可以无级调整180度

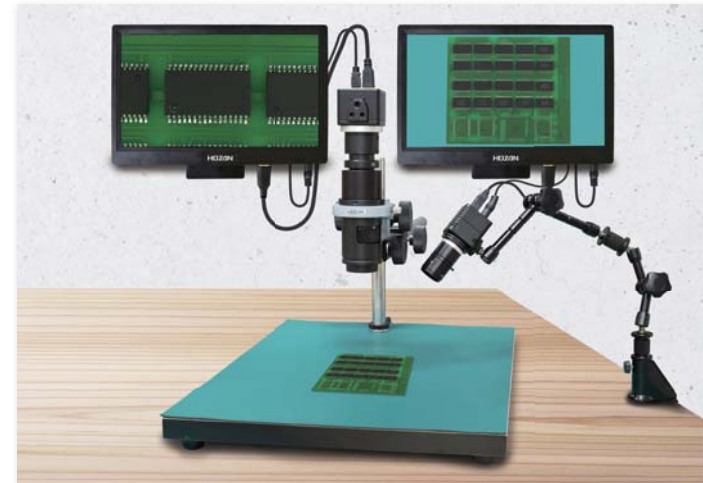

Wall mounting example
墙上安装示例

L-859 DISPLAY MONITOR



It is a dedicated LCD monitor which can be used for HDMI camera. A small size of 11.6 inches that does not get in the way on the desk. The liquid crystal adopts the IPS method with wide viewing angle, glare (gloss) which coloring is good and the image is displayed beautifully. There is a mounting hole on the back of the main unit, and also a table stand and a camera screw conversion plate are attached, it corresponds to every use scene.

显示器

这是一款可用于HDMI相机的专用液晶显示器。11.6英寸的小尺寸不会挡在桌子上。液晶采用IPS方式，广视角，眩光(光泽)，着色性好，图像显示美观。主机背面有一个安装孔，并附有一个桌面支架和一个摄像机螺丝转换板，它对应于各种使用场景。

Liquid crystal method 液晶法	Glare (gloss) liquid crystal IPS method 眩光(光泽)液晶IPS方法
Screen size 屏幕尺寸	11.6 type wide 11.6型宽
Number of effective pixels 有效像素数	1920 x 1080
Input connector 输入连接器	HDMI
Power supply 电源	DC 12 V (AC adapter included) (包括AC适配器)
power consumption 功耗	4W
Dimensions 外部尺寸	282 (W) x 180 (H) x 15.3 (D) mm (not including protrusions) (不包括突起)
Weight 重量	400 g (excluding accessories) (不含配件)

■ AC adapter, desktop stand, camera screw conversion plate, with 4 mounting screws
■ AC适配器, 桌面支架, 相机螺丝转换板, 带有4个安装螺丝

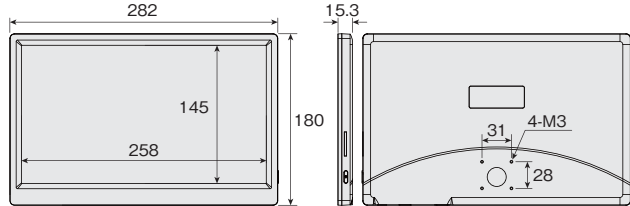

You can attach to the L-505, L-803 by using the attached camera screw conversion plate.
您可以使用附带的相机螺丝转换板将其安装到L-505, L-803上。

With the camera screw fixing, the monitor can be installed at an arbitrary angle.
通过相机螺丝固定，显示器可以安装在任意角度。



You can use the desk with a flexible arm large.
您可以使用灵活的手臂用法示例。

Lineup of versatile lighting that broadens the scope of inspection 多功能照明系列扩大了检测范围

LED Light LED照明灯	L-703 	L-711 	L-715 (同轴落射) 	L-717 (面发光)
Substrate 基板				
After metal milling 金属研磨后				
Glossy surface (metal) 光泽表面(金属)				
Uneven part (metal) 不均匀的部分(金属)				
Uneven part (dry carbon) 不均匀的部分(干碳)				
Hole (dent) 孔(凹痕)				
Translucent material (jewelry) 半透明材料(珠宝)				



L-703 100-240V
LED FLEX NECK LIGHT
 LED照明灯

LED	1 High-brightness white LEDs x 2	高亮度白色LED 1个×2
LED life LED寿命	Approx. 10,000 HRS *Varies to the used environment.	约10000小时 会根据使用环境有所变化。
Color temp. 色温度	6500 K	
Rated voltage 定格电压	12 VDC (with AC adapter) (标配AC 适配器)	
Power consumption 消费电力	6 W	
External dimensions 外形尺寸	Unit body 本体 90 (W) × 37 (H) × 100 (D) mm	
Arm length 支臂长	400mm	
Weight 重量	425g	

Brightness comparison data
 亮度比较数据

Distance from light source mm 离发光部的距离	No diffusion filter 没有扩散过滤器		With diffusion filter 带扩散过滤器	
	50	100	50	100
1 Lights 1个灯	249000	81000	35400	11500
2 Lights 2个灯	337000	126800	38300	14400

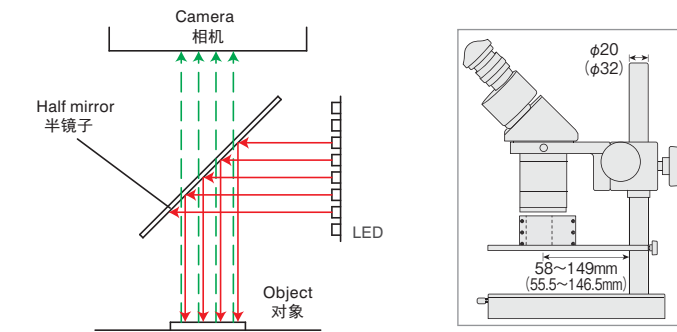
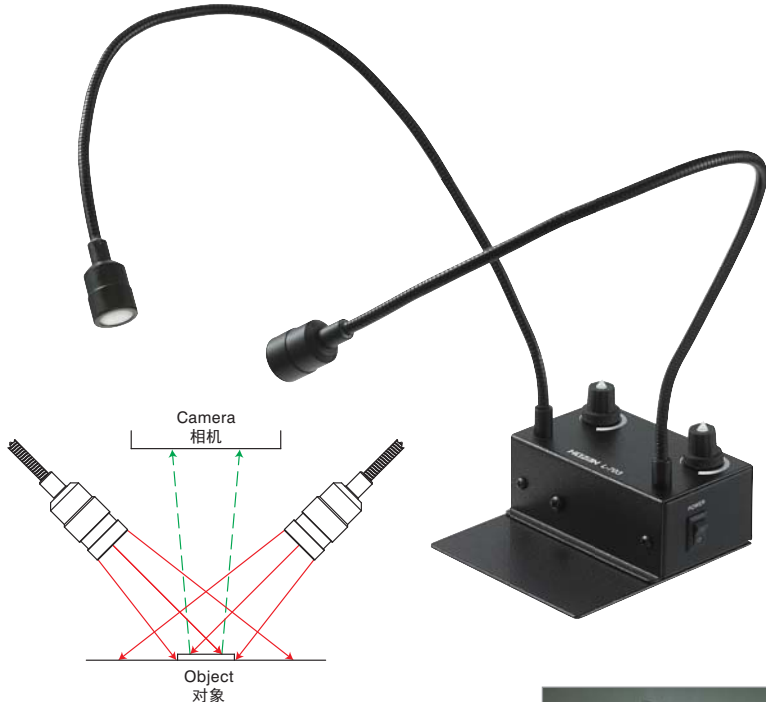
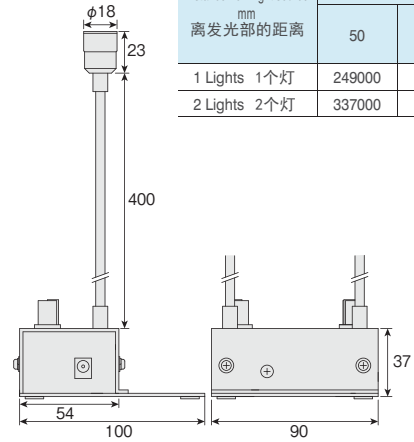

L-715 100-240V
LED COAXIAL EPISCOPIC LIGHT
 LED照明灯

LED	White LED x 64	白色LED × 64个
LED life LED寿命	Approx. 30,000 HRS *Varies to the used environment.	约30000小时 会根据使用环境有所变化。
Color temp. 色温度	6500 K	
Rated voltage 定格电压	12 VDC (with AC adapter) (标配AC 适配器)	
Power consumption 消费电力	2.7 W	
Light emitting surface dimension 发光表面尺寸	32 mm × 32 mm	

Light brightness (at full power)
 照明灯的亮度 (调光100%时)

Distance from light source mm 离发光部的距离	Brightness lx 亮度
30	10300
60	4800
100	2300

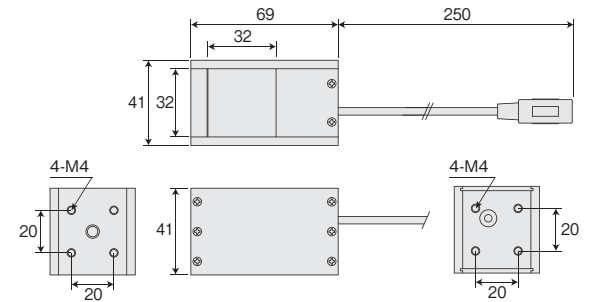

L-711 100-240V RoHS
LED RING LIGHT
 LED照明灯

LED	White power LED × 12	白色PowerLED 12个
LED life LED寿命	Approx. 10,000 HRS *Varies to the used environment.	约10000小时 会根据使用环境有所变化。
Color temp. 色温度	6600 K	
Rated voltage 定格电压	12 VDC (with AC adapter) (标配AC 适配器)	
Power consumption 消费电力	8.5 W	
External dimensions 外形尺寸	91 φ × 31 mm (不会突起部)	
Weight 重量	150 g	

Brightness comparison data (at full power)
 亮度比较数据 (调光100%时)

Distance from light source mm 离发光部的距离	L-711	L-711 + L-711-1
30	35000	21000
40	30900	17700
50	24500	15100
60	22200	13200
80	16400	9700
100	12100	7500

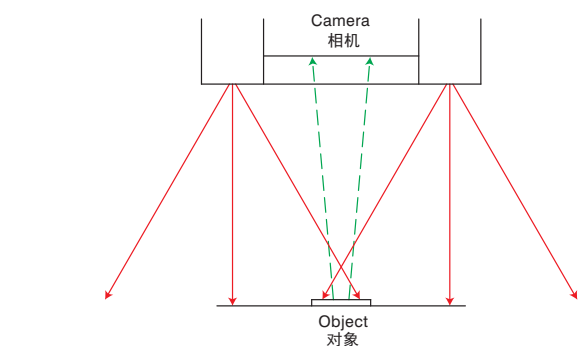

Optional parts 另售部品

L-711-1
FILTER
 扩散过滤器



L-717 100-240V
LED PLANE EMISSION LIGHT
 LED照明灯

LED	White LED x 64	白色LED × 64个
LED life LED寿命	Approx. 30,000 HRS *Varies to the used environment.	约30000小时 会根据使用环境有所变化。
Color temp. 色温度	6500 K	
Rated voltage 定格电压	12 VDC (with AC adapter) (标配AC 适配器)	
Power consumption 消费电力	2.7 W	
Light emitting surface dimension 发光表面尺寸	50mm × 50mm	

Light brightness (at full power)
 照明灯的亮度 (调光100%时)

Distance from light source mm 离发光部的距离	Brightness lx 亮度
10	61500
30	35400
60	16200

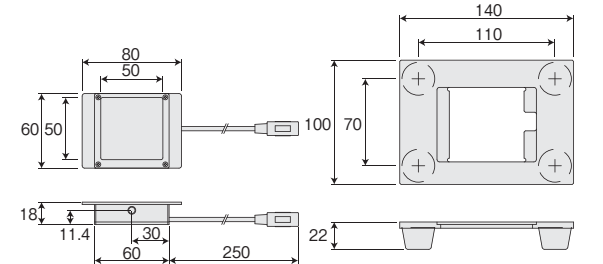
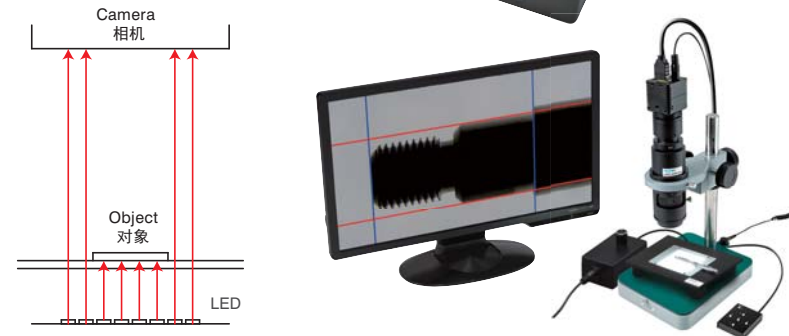

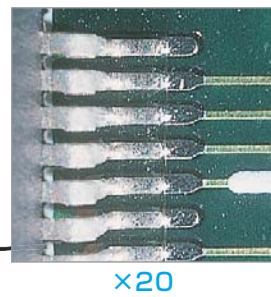
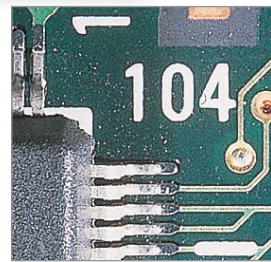

L-50 STEREO MICROSCOPE 实体显微镜



Total magnification (view)	综合放大倍率	10× / 20×
Objective lens	物镜	1× / 2× selection format 旋转式
Eyeiece	目镜	WF10× (L-511)
Sight adjustment	视野调整	Monocular adjustment type, ±5Dptr 单眼调整式
Working distance	工作距离	80 mm
Focus adjustment	焦距调整	Head scope up/down type 镜筒上下式
Stereo head spec.	镜筒形状	Binocular 45° Tilted Head scope 倾斜角45°
Eye width adjustment range	眼宽调整范围	55 to 74 mm, left/right independent type 左右独立式
Table dimensions	台座尺寸	145 (W) × 185 (D) mm
Support height	支柱高度	245 mm
Distance from lens center to support	从镜头中心到支柱	90 mm
Weight	重量	2.4 kg

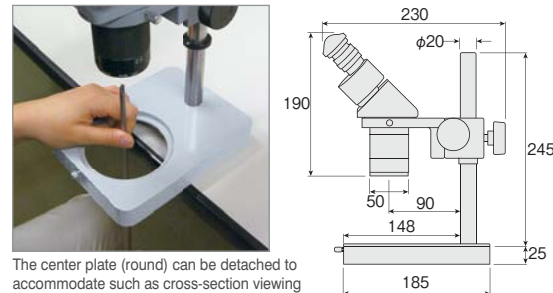

The center plate (round) can be detached to accommodate such as cross-section viewing of long objects, as shown.
被检查物为长条形时, 可拆下中央的圆形盖, 将被检查物立起检查。

L-50 Magnification table 倍率表

Objective lens 物镜	1×		2×		1×		2×		1×		2×													
	Magnification x	Field of view mmφ	Working distance mm	Magnification x	Field of view mmφ	Working distance mm	Magnification x	Field of view mmφ	Working distance mm	Magnification x	Field of view mmφ	Working distance mm												
CONVERSION LENS 转换镜	—																							
EYEPIECE 目镜	L-57-0.5						L-57-1.5						L-57-2.0											
L-511 (WF10×)	10	18	80	20	9	80	5	36	150	10	18	150	15	12	40	30	6	40	20	9	27	60	3	27
L-513 (WF15×)	15	12	80	30	6	80	7.5	24	150	15	12	150	22.5	8	40	45	4	40	30	6	27	60	3	27
L-512 (WF20×)	20	9	80	40	4.5	80	10	18	150	20	9	150	30	6	40	60	3	40	40	4.5	27	80	2.2	27

Standard item * The "working distance" is the distance from the end of the filter to the subject.
标准品 ※动作距离是滤光片端面至被观察物的距离

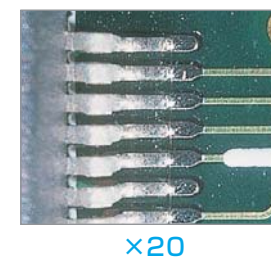
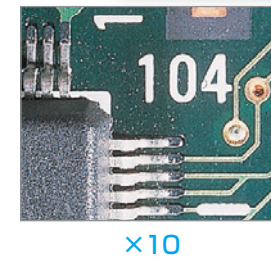

L-51 STEREO MICROSCOPE 实体显微镜



Total magnification (view)	综合放大倍率	10× / 20×
Objective lens	物镜	1× / 2× selection format 旋转式
Eyeiece	目镜	WF10× (L-546-10)
Sight adjustment	视野调整	Monocular adjustment type, ±5Dptr 单眼调整式
Working distance	工作距离	84 mm
Focus adjustment	焦距调整	Head scope up/down type 镜筒上下式
Stereo head spec.	镜筒形状	Binocular 45° Tilted Head scope 倾斜角45°
Eye width adjustment range	眼宽调整范围	54 to 75 mm, left/right independent type 左右独立式
Table dimensions	台座尺寸	200 (W) × 255 (D) mm
Support height	支柱高度	282 mm
Distance from lens center to support	从镜头中心到支柱	133 mm
Weight	重量	3.8 kg

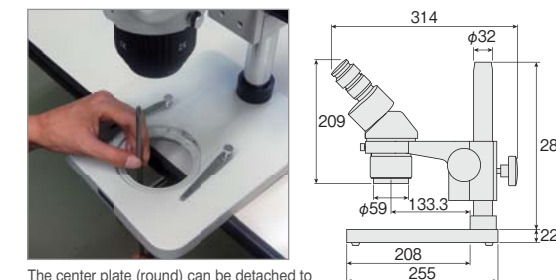

The center plate (round) can be detached to accommodate such as cross-section viewing of long objects, as shown.
被检查物为长条形时, 可拆下中央的圆形盖, 将被检查物立起检查。

L-51 Magnification table 倍率表

Objective lens 物镜	1×		2×		1×		2×		1×		2×													
	Magnification x	Field of view mmφ	Working distance mm	Magnification x	Field of view mmφ	Working distance mm	Magnification x	Field of view mmφ	Working distance mm	Magnification x	Field of view mmφ	Working distance mm												
CONVERSION LENS 转换镜	—																							
EYEPIECE 目镜	L-57-0.5						L-57-1.5						L-57-2.0											
L-546-10 (WF10×)	10	20	84	20	10	84	5	40	163	10	20	163	15	13.3	38	30	6.7	38	20	10	27	40	5	27
L-546-20 (WF20×)	20	10	84	40	5	84	10	20	163	20	10	163	30	6.7	38	60	3.3	38	40	5	27	80	2.5	27

Standard item * The "working distance" is the distance from the end of the filter to the subject.
标准品 ※动作距离是滤光片端面至被观察物的距离

10 / 20 / 40×

10 / 20 / 40×
11× ↔ 165×

20 / 40×
6.5× ↔ 52×

5 / 10 / 20×
9.9× ↔ 165×

10 / 20×
6.5× ↔ 52×



With lighting 随着照明

L-711	L-703
L-KIT538	L-KIT539

With lighting 随着照明

L-711	L-703
L-KIT541	L-KIT542

With lighting 随着照明

L-711	L-703
L-KIT609	L-KIT610

With lighting 随着照明

L-711	L-703	L-717	L-715
L-KIT544	L-KIT545	L-KIT546	L-KIT547

With lighting 随着照明

L-711	L-703	L-717	L-715
L-KIT612	L-KIT613	L-KIT614	L-KIT615

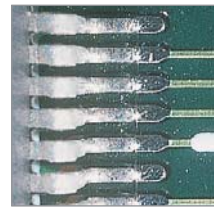
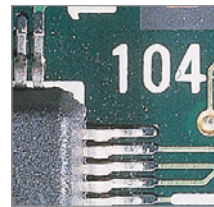

L-46
STEREO MICROSCOPE (zoom type)
实体显微镜 (推拉镜头型)



Total magnification	综合倍率	7 to 45x	7~45x
Objective lens	物镜	0.7 to 4.5 x (zoom ratio 6.4)	0.7~4.5x (变焦比6.4)
Eyeiece	目镜	WF10 x (L-546-10)	
Sight adjustment	视野调整	Independent left / right adjustment type, ± 5Dptr	左右独立式, ±50Dptr
Working distance	动作距离	84 mm (equipped with lens filter / ring)	(装有滤镜/镜头环)
Focus adjustment	焦点调整	Head scope up / down type (adjustable range: 50 mm)	镜筒上下式(可移动范围50mm)
Stereo head spec.	镜筒仕様	Binocular 45° Tilted Head scope	双眼45° 倾斜镜筒
Eye width adjustment range	眼宽调整范围	54 to 75 mm left / right interlocking type	54~75mm·左右连动式
Table dimensions	基本尺寸	200 (W) x 255 (D) mm	
Support height	支柱高度	282 mm	
Distance from lens center to support	镜头中心到支柱距离	133 mm	
Weight	重量	4.2kg	



The center plate (round) can be detached to accommodate such as cross-section viewing of long objects, as shown.
长物的侧面等从中间的圆孔取出, 对象物能够通过下面进行检视。

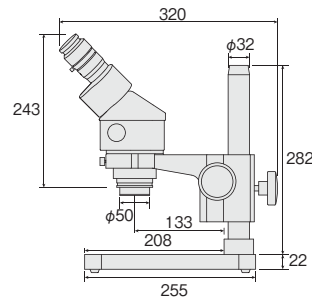

L-46 Magnification table 倍率表

Standard item 标准品 * The "working distance" is the distance from the end of the filter to the subject.
* 动作距离是滤光片端面至被观察物的距离

Objective lens 物镜	0.7~4.5x											
	—			L-57-0.5			L-57-1.5			L-57-2.0		
CONVERSION LENS 转换镜	—											
EYEPIECE 目镜	Magnification x 倍率	Field of view mmφ 视野	Working distance mm 动作距离	Magnification x 倍率	Field of view mmφ 视野	Working distance mm 动作距离	Magnification x 倍率	Field of view mmφ 视野	Working distance mm 动作距离	Magnification x 倍率	Field of view mmφ 视野	Working distance mm 动作距离
L-546-10(WF10x)	7~45	28.5~4.4	84	3.5~22.5	57.1~8.9	160	10.5~67.5	19.0~2.9	43	14~90	14.3~2.2	26
L-546-20(WF20x)	14~90	14.3~2.2		7~45	28.5~4.4		21~135	9.5~1.5		28~180	7.1~1.1	

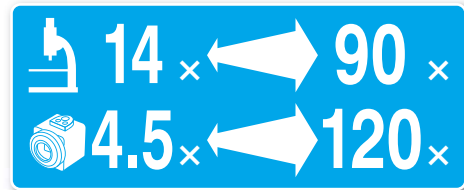
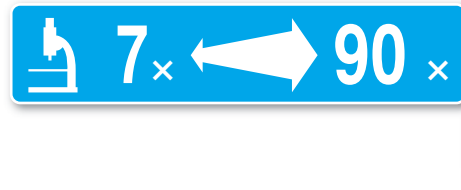
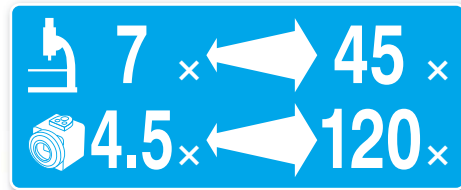

L-KIT619

With lighting 随着照明

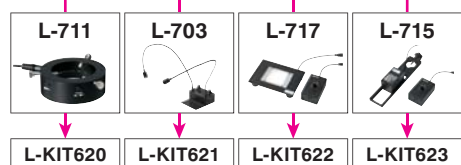

L-KIT616

With lighting 随着照明



L-KIT624

With lighting 随着照明



A Multi-purpose magnifier with flexible arm and ring lamp that offers high-quality at a low price.

臂式放大镜带有环形荧光灯, 具有多种用途。实现了基本性能的高品质与可以欣然接受的低价格。



Large diameter white lens
The white lens provides brighter, more vivid images than the blue lens.

大口径白色放大镜片
白色放大镜片比蓝色放大镜片更能看清被检查物。

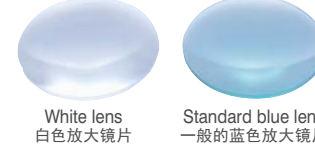

Arm with built-in spring 内弹簧臂



LED lighting LED照明



L-678 100-240V
LED ILLUMINATED MAGNIFIER
臂式放大镜



Magnification 倍率	1.75x
Lens diameter 透镜尺寸	170mm φ
LED	White power LED x 56 白色PowerLED 56个
LED life LED寿命	Approx. 35,000 HRS 约35000小时 *Varies to the used environment. *根据使用环境有所变化。
Color temp. 色温度	6500K
Rated voltage 定格电压	12 VDC (with AC adapter) (标配AC适配器)
Arm length 臂长	855mm
Max. clamp opening width 夹头最大开口	65mm
Power consumption 消费电力	5W
Weight 重量	2.6kg

Brightness comparison data 亮度比较数据

Distance from light source mm 发光部的距离	Brightness lx 亮度
300	2300



L-95-9/10
FOLDING MAGNIFIER
手持式放大镜



Part no. 型号	Magnification x 倍率	Lens dimensions mmφ 透镜尺寸	Material 材质	OAL mm 全长	Weight g 重量
L-95-9	3/6/9	23	Rigid plastic (lens) 硬质塑料(镜头)	48	32
L-95-10	10				24

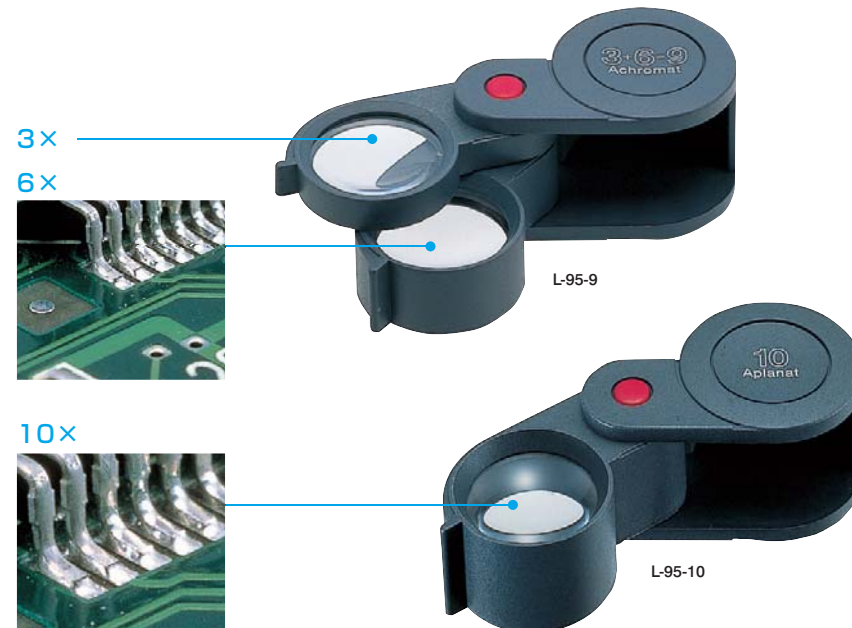

HOZAN Web Site

网站

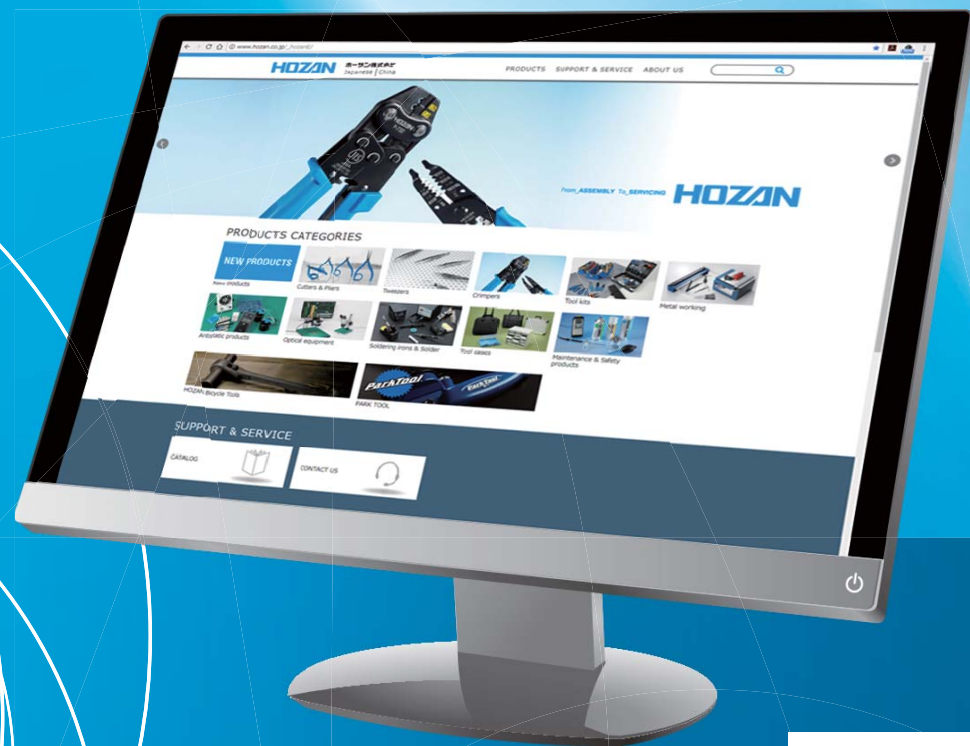

English
<http://www.hozan.co.jp/E/>



Chinese
<http://www.hozan.co.jp/china/>



D	F-103	34	L-808-3	39	L-KIT552	44	L-KIT614	50	P-57-175	5	P-881-ESD	12	S-201-230	22	
	F-104	34	L-835	35	L-KIT553	44	L-KIT615	50	P-57-200	5	P-882	11	S-351	20	
D-13	16	F-109	33	L-850-1	35	L-KIT554	44	L-KIT616	51	P-59-175	5	P-886	11	S-372	22
D-16	17	F-109-TA	33	L-850-2	39	L-KIT555	44	L-KIT617	51	P-64	14	P-887	10		
D-16-1B	17	F-109-1	33	L-851	35	L-KIT556	44	L-KIT618	51	P-75	7	P-888	12	W	
D-16-2B	17	F-109-1-TA	33	L-859	45	L-KIT557	44	L-KIT619	51	P-86-125	11	P-890	10	W-81	19
D-16-3B	17	F-109-4	34	L-860	35	L-KIT558	44	L-KIT620	51	P-86-150	11	P-891	10	W-91	19
D-16-4B	17	F-126	31	L-KIT500	42	L-KIT559	44	L-KIT621	51	P-86-175	11	P-891-ESD	12	W-96	19
D-16-5	17	F-127	28	L-KIT501	42	L-KIT560	44	L-KIT622	51	P-87	11	P-892	10	W-98	19
D-20	17	F-142	30	L-KIT502	42	L-KIT561	44	L-KIT623	51	P-89	13	P-894	10	W-99	19
D-20-11	17	F-145	31	L-KIT503	42	L-KIT562	44	L-KIT624	51	P-90-A	6	P-895	10	W-110	18
D-20-12	17	F-152	30	L-KIT504	42	L-KIT563	44	L-KIT625	51	P-90-B	6	P-898	10	W-110-1.5	18
D-20-14	17	F-153	30	L-KIT505	42	L-KIT564	44	L-KIT626	51	P-90-C	6	P-899	10	W-110-2	18
D-20-15	17	F-155	30	L-KIT506	42	L-KIT565	44			P-90-F	6	P-960	6	W-110-2.5	18
D-20-16	17	F-166	28	L-KIT507	42	L-KIT566	44	N		P-211Z-150	5	P-963	6	W-110-3	18
D-20-17	17	F-190-L	31	L-KIT508	42	L-KIT567	44			P-211Z-200	5	P-967	6	W-110-4	18
D-44	15	F-190-M	31	L-KIT509	42	L-KIT568	44	N-4-125	2	P-214	5	P-968	6	W-110-5	18
D-52	15	F-206	30	L-KIT510	42	L-KIT569	44	N-4-150	2	P-220	5	P-970	6	W-110-6	18
D-54	15	F-206-TA	30	L-KIT511	42	L-KIT570	44	N-5-125	2	P-221	5	P-977	6	W-111	18
D-58	15	F-240	29	L-KIT512	42	L-KIT571	42	N-5-150	2	P-244	5	P-978	6	W-111-1.5	18
D-59	16	F-241	29	L-KIT513	42	L-KIT572	42	N-9-125	2	P-245	5			W-111-2	18
D-66	17	F-245	29	L-KIT514	42	L-KIT573	42	N-9-150	2	P-610-G	9	PP		W-111-2.5	18
D-67	17	F-310-L	28	L-KIT515	42	L-KIT574	42	N-12	2	P-640-P	9	PP-110	11	W-111-3	18
D-68	16	F-310-M	28	L-KIT516	42	L-KIT575	42	N-16	3	P-640-S	9	PP-111	11	W-111-4	18
D-69	16	F-310-S	28	L-KIT517	42	L-KIT576	42	N-18	3	P-641-S	9	PP-112	11	W-111-5	18
D-331-100	15	F-315	28	L-KIT518	40	L-KIT577	42	N-23	2	P-642-S	9	PP-114	11	W-111-6	18
D-331-150	15	F-727	27	L-KIT519	40	L-KIT578	42	N-25-125	2	P-643-S	9	PP-120	13	W-112	18
D-332-100	15	F-728	27	L-KIT520	40	L-KIT579	42	N-25-150	2	P-644-P	9	PP-121	13	W-112-1.5	18
D-332-150	15	F-729	27	L-KIT521	40	L-KIT580	38	N-31	1	P-644-S	9	PP-122	13	W-112-2	18
D-530-75	15	F-730	26	L-KIT522	40	L-KIT581	38	N-32	1	P-645-S	9	PP-124	13	W-112-2.5	18
D-540-100	15	F-735	26	L-KIT523	40	L-KIT582	38	N-33	2	P-646-C	10			W-112-3	18
D-550-100	15	F-736	26	L-KIT524	40	L-KIT583	38	N-34	1	P-646-D	10			W-112-4	18
D-555-100	15	F-741	27	L-KIT525	40	L-KIT584	38	N-35	1	P-650-S	9	S		W-112-5	18
D-555-300	15	F-742	27	L-KIT526	40	L-KIT585	38	N-36	2	P-651	13	S-1	25	W-112-6	18
D-630-75	15	F-743	27	L-KIT527	40	L-KIT586	38	N-55	1	P-652	13	S-3	25	W-113	18
D-630-100	15	F-744	27	L-KIT528	40	L-KIT587	38	N-57	1	P-653	11	S-7	22	W-113-1.5	18
D-640-100	15	F-745	27	L-KIT529	40	L-KIT588	38	N-58	1	P-654	11	S-7-230	22	W-113-2	18
D-650-100	15	F-746	27	L-KIT530	40	L-KIT589	38	N-838	3	P-704	8	S-10	24	W-113-2.5	18
D-655-100	15	F-750	28	L-KIT531	40	L-KIT590	38	N-839	3	P-706	8	S-10-230	24	W-113-3	18
D-745	16	F-757	27	L-KIT532	40	L-KIT591	38	N-841	3	P-707	8	S-22	24	W-113-4	18
D-963	16	F-840	26	L-KIT533	40	L-KIT592	38			P-722	7	S-22-230	24	W-113-5	18
		F-841-A	26	L-KIT534	40	L-KIT593	38	P		P-726	7	S-34	25	W-230-100	19
F		F-841-B	26	L-KIT535	40	L-KIT594	38	P-12	4	P-732	7	S-35	25	W-230-150	19
		F-843-A	26	L-KIT536	40	L-KIT595	38	P-14-125	4	P-736	8	S-35-230	25	W-230-200	19
F-27	28	F-843-B	26	L-KIT537	49	L-KIT596	38	P-14-150	4	P-743	7	S-51	20	W-230-250	19
F-28	28			L-KIT538	49	L-KIT597	38	P-15-125	4	P-806	14	S-53	20	W-510	17
F-61-L	32	L		L-KIT539	49	L-KIT598	38	P-15-150	4	P-807	14	S-60-B	24	W-521	19
F-61-M	32			L-KIT540	49	L-KIT600	38	P-16	4	P-808	14	S-60-B230	24		
F-64-L	32	L-46	51	L-KIT541	49	L-KIT601	38	P-22	4	P-809	14	S-75	23		
F-64-M	32	L-50	49	L-KIT542	49	L-KIT602	38	P-33	4	P-843	14	S-75-230	23	Z	
F-64-S	32	L-51	50	L-KIT543	50	L-KIT603	38	P-34	4	P-845	12	S-76	23	Z-364	14
F-66-L	32	L-95-9	52	L-KIT544	50	L-KIT604	38	P-35	3	P-848	9	S-80	21		
F-66-M	32	L-95-10	52	L-KIT545	50	L-KIT607	38	P-36	3	P-860-125	14	S-80-230	21		
F-66-S	32	L-678	52	L-KIT546	50	L-KIT608	49	P-37	3	P-860-150	14	S-81	21		
F-78	27	L-703	47	L-KIT547	50	L-KIT609	49	P-39	4	P-863-150	14	S-81-230	21		
F-79	27	L-711	47	L-KIT548	44	L-KIT610	49	P-43-150	5	P-873	12	S-201	22		
F-101	34	L-711-1	47	L-KIT549	44	L-KIT611	50	P-43-175	5	P-878	12				
F-101-TA	34	L-715	48	L-KIT550	44	L-KIT612	50	P-51	1	P-880	11				
F-102	34	L-717	48	L-KIT551	44	L-KIT613	50			P-881	11				



HOZAN HOZAN TOOL INDUSTRIAL CO.,LTD.

1-2-12 Saiwaicho,Naniwa-ku,Osaka 556-0021,Japan
本社 〒556-0021 大阪市浪速区幸町1-2-12

E-mail :info@hozan.co.jp

English <http://www.hozan.co.jp/E/>

Chinese <http://www.hozan.co.jp/china/>

Specification and appearance of products listed in this catalog are subject to change without notice.
All information in this catalog is as of January 1, 2018.

本目录中所列产品的规格和外观如有更改，恕不另行通知。
本目录中的所有信息均为2018年1月1日。

