



QMS EMS
JIS Q 9001:2000
JIS Q14001:2004
JSAQ097, JSAE1356



JAB
QMS EMS
Accreditations
R001, RE005

本製品は特許取得 (ISO9001) 対応工場にて製造されています。



TTM-04SP

TTM-04SP

PLUG-IN DIGITAL TEMPERATURE CONTROLLER



TTM-04SP

TOHO ELECTRONICS INC.



Features

● Improved controllability with a new PID algorithm

Equipped with a control method that reduces start-up time and suppresses overshoots following external disturbances.

● Self-Tuning PID (Heating/Cooling)

The most suitable PID constant for the relevant control is automatically calculated. The PID constant is calculated when the parameters are amended and when tuning is carried out, when unstable temperatures occur owing to external disturbances, and when hunting occurs.

- Blind Function

Displays and allows the setup of only the required parameters among all parameters.

● Simple Timer Function

The [Start or stop control when a predetermined period has elapsed] control can be set up for a single unit. The timer function can be used independently (ON/OFF for event output.)

● Priority Screens

Required parameter screens can be displayed and set up by displaying the operation mode screen without actually calling the parameter screens (maximum 9 screens.)

● Multiple Input

The use of the front-panel keys enables the input type to be switched between the thermocouple and the platinum resistance thermometer.

● External Rating

Conforms to UL-CUL-CE (pending application)

● Protective mechanism

Conforms to IP66 equivalence.

● Compact Size

Extremely compact with a depth of only 69mm.

● Manual Control (Balanceless & Bumpless)

The manual output function can be used with a wide range of instrumentation systems.

● Sampling Cycle: 250ms

● Loader Communication Function

The optimal function for parameter setup.

Cable: Optional (sold separately)—TTM-Loader

Software: Optional (free)—May be downloaded from our web site.

● Digital PV Filter

Possible to set up a software filter to cope with rapid fluctuations in the input value.

● Miscellaneous

(1) Shift setting to the OFF position during ON/OFF control (for both Output 1 and 2)

(2) Heating / Cooling control (equipped with PID control when in the cooling mode.)

(3) Ramp function.

Nomenclature



Operation Key Descriptions

EV1	Contact output 1 Output monitor
EV2	Contact output 2 Output monitor
OUT1	Output 1 Output monitor
OUT2	Output 2 Output monitor
RDY	Illuminated when in the READY mode
MODE	Mode key Used to switch between screens.
FUNC	Executes the specified functions: (1) Digit shift key (selected digit flashes) (2) AT key (3) RUN/READ key (4) Timer Start/Reset
PV	Measurement value, operational volume, remaining timer time (alarm, PID)
SV	Parameter value, operational volume, remaining timer time
▼	Used to decrease the specified value. - Press for 1 to 10 consecutive seconds: 1 digit/100ms - Press for 10 to 20 consecutive seconds: 10 digit/100ms - Press for 20 or more consecutive seconds: 100 digit/100ms
▲	Used to increase the specified value. - Press for 1 to 10 consecutive seconds: 1 digit/100ms - Press for 10 to 20 consecutive seconds: 10 digit/100ms - Press for 20 or more consecutive seconds: 100 digit/100ms

Operation Flow

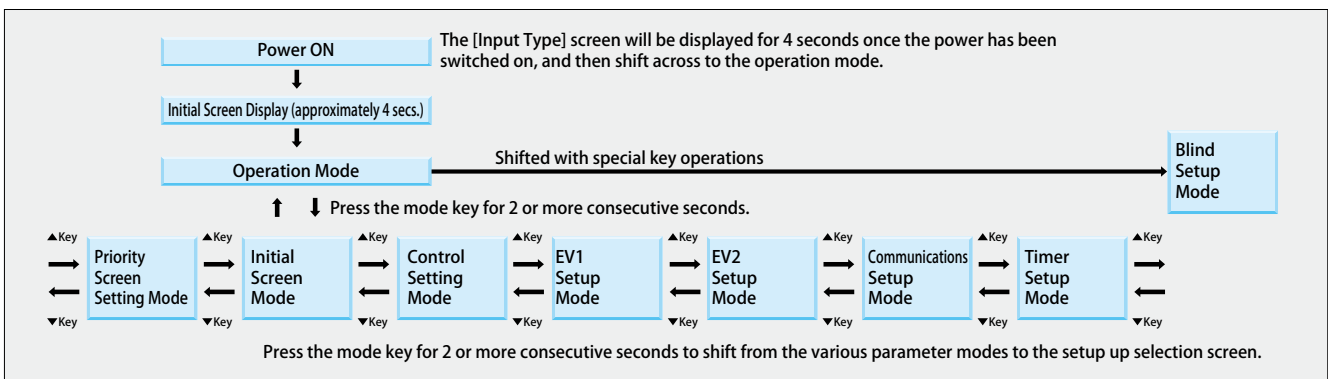

Standard Specifications

Input Type	Thermocouple	K, J, R, T, N, S, B (JIS 1602-1995)		The use of the front-panel keys enables the input type to be switched between the thermocouple and the resistance thermometer.
	Resistance Thermometer	Pt100, JPt100 (external resistance 10 ohms or less (per cable)) (JIS1604-1997)		
Display	PV Character Display	4-digit, green, 10mm (H)		
	SV Set Value Display	4-digit, red, 8mm (H)		
	Various Function Displays	Red LED (EV1, EV2, OUT1, OUT2, RDY)		
Control	PID Auto-Tuning Self-Tuning	Proportional band (P1)	Set limiter span between 0.1 and 200.0%	
		Proportional band (2) on Output 2	(Multiples for the P1 proportional band) x0.10 to x10.00	
		Integration time (I)	0 to 3,600 seconds (integration operations set at OFF when 0)	
		Derivative action time (D)	0 to 3,600 seconds (derivative action set at OFF when 0)	
		Proportional cycle (T1, T2)	1 to 120 seconds	
		Dead band (DB)	-100.0 to +100.0 or -100 to +100 (°C)	
	ON/OFF	Control sensitivity (C1, C2)	0 to 999 or 0.0 to 999.9 (°C)	
	Output 1, 2 OFF point	Position of setting (CP1, CP2) -199 to 999 or -199.9 to 999.9		
Control Output	Relay Contact	AC250V, 3A (load resistance), 1a contact (however, AC250V, 1A (load resistance), 1a contact for output 2 when heating/cooling is in operation)		
	SSR Drive Voltage	DC 0 to 12V (load resistance 600 ohms or more)		
Sampling Cycle		0.25 seconds (same for the output amendment cycle)		
Settings and Instruction Accuracy	Thermocouple	+0.5% , FS ± 1 digit (ambient temperature of 23 ± 10°C) The load area is ± 1% FS ± 1 digit. Not rated below 400°C for B thermocouple.		
	Resistance Thermometer:	± 0.3% FS ± 1 digit (ambient temperature of 23 ± 10°C) 0 to 50°C ± 0.5% FS ± 1 digit		
Memory Element		EEPROM		
Input Power		AC100 to 240V (-15% , +10%) 50/60Hz		
Weight		200g or less		
Power Consumption		10VA or less (AC264V)		
Accessories		Instruction manual and installation attachment * Note that the socket is not supplied		
Operating Conditions		0 to 50°C , 20 to 90% RH (no condensation)		
Storage Conditions		-25 to 70°C , 5 to 95% RH (no freezing or condensation)		
Functions	Manipulated Variable Limiter (ML1, MH1, ML2, MH2)	0.0 to 100%		
	Setting Limiter (SLL, SLH)	See the [Input and Calibration Range] chart.		
	Control Mode Switch (CNT)	Auto-tuning PID type A (normal operations, reverse operations), Auto-tuning PID type B (normal operations, reverse operations)		
		Self-tuning PID (normal operations, reverse operations), ON/OFF (normal operations, reverse operations)		
	PV Correction Zero Point Setting (PVS)	Thermocouple / resistance thermometer: -199 to 999 or -199.9 to 999.9 (°C)		
	PV Correction Gain Setting	0.50 to 2.00 (multiples)		
	Input Filter	0 to 99 (seconds)		
	Manual Reset (PBB)	0.0 to 100.0% , -100.0 to 100.0% of the proportional band (during heating/cooling control)		
	Timer Operation Mode (TIM)	0 minute 00 seconds to 59 minutes 59 seconds 0 hours 00 minutes to 99 hours 59 minutes Accuracy: Set time ± (1.5% + 0.5 seconds)		
	Decimal Point Shift (DP)	Display numerals after decimal point: Yes / No		
	Manual Control	Manual control possible (balanceless / bumpless)		
	Run/Ready	Run/Ready switching possible.		
	Blind Function	Possible to set arbitrary parameter screens to non-display.		
	Auto-Tuning Coefficient	Possible to set the coefficient in the proportional band calculated with auto-tuning.		
	Function Keys	Function keys can be selected from Digit Shift, AT, Run/Ready and Timer Start/Reset.		
	Priority Screen	Possible to display arbitrary parameter screens in the operation mode (9 screens.)		
	Lock Function (LOC)	4 modes (OFF, ALL, operation mode lock, lock all but operation mode)		
Self-Diagnosis Function	EEPROM data check (Err0), A/D converter operation check (Err1), auto-tuning check (Err2), built-in watchdog timer.			
Ramp Function	Operations: SV variations set every minute during SV amendment. Setting Range: 0.0 to 999.9 Ramp function set at OFF when this is 0.0. Setting Unit: 0.1°C /minute (thermocouple/resistance thermometer input type) Accuracy: ± (1.5% + 0.5 seconds)			
Contact Output (EV1) Contact Output (EV2 or OUT2)		Functions: PV contact output (8 modes), special function (1 mode), additional functions (3 modes). Setting Range: Thermocouple/resistance thermometer: -199.9 to 999.9 or -1999 to 9999 (°C) Sensitivity: Thermocouple/resistance thermometer: 0.0 to 999.9 or 0 to 9999 (°C) Rating: AC250V 1A (load resistance) 1a contact. If heating/cooling control is selected when OUT2 has been specified with contact output 2, OUT2 becomes the cooling output if OUT1 is the heating output, and OUT2 becomes the heating output if OUT1 is the cooling output. Contact Polarity: Possible to select with normal open or normal close.		

Input and Calibration Range

(The thermocouple and resistance thermometer can be varied at will.)

Thermocouple		Setting Range		Display Range	
		No Decimal Point	Decimal Point	No Decimal Point	Decimal Point
K	°C	-200 to 1372	-199.9 to 990.0	-210 to 1382	-199.9 to 999.9
J	°C	-200 to 850	-199.9 to 850.0	-210 to 860	-199.9 to 860.0
R	°C	0 to 1700	—	-10 to 1710	—
T	°C	-200 to 400	-199.9 to 400.0	-210 to 410	-199.9 to 410.0
N	°C	-200 to 1300	-199.9 to 990.0	-210 to 1310	-199.9 to 999.9
S	°C	0 to 1700	—	-10 to 1710	—
B	°C	0 to 1800	—	-20 to 1820	—

Resistance Thermometer		Setting Range		Display Range	
		No Decimal Point	Decimal Point	No Decimal Point	Decimal Point
Pt100 (JIS/IEC)	°C	-190 to 500	-199.9 to 500.0	-199 to 530	-199.9 to 530.0
JPt100 (JIS)	°C	-190 to 500	-199.9 to 500.0	-199 to 520	-199.9 to 520.0

Timer Operation Mode

Start Mode

1	Auto start : (ON delay)
2	Manual start : (ON delay)
3	Event start : (ON delay)
4	Auto start : (OFF delay)
5	Manual start : (OFF delay)
6	Event start : (OFF delay)
7	SV start : (OFF delay)

OFF Delay: Control halted and the event output set at OFF after the time-up.

ON: Delay: Control started and the event output set at ON after the time-up.

*The destination for the output can be set in the control output and event output.

Contact Output Mode

(Alarm)

Special Function Types

0	None
1	Abnormal PV contact output

Additional Functions

0	None
1	Holding
2	Awaiting sequence
3	Holding + awaiting sequence

Only 0 and 1 can be selected when the special function type is 0.

PV Event Function Types

0	None
1	Deviation high and low limit
2	Deviation high limit
3	Deviation low limit
4	Deviation high and low range
5	Abusolute value high and low limit
6	Abusolute value high limit
7	Abusolute value low limit
8	Abusolute value high and low range

Timer Output Destination Setting

0	Timer not used
1	Control
2	Event 1 output

Terminal Layout

Name	Terminal No.	Relay	SSR
OUT1	⑤	C	-
	④	NO	+

Name	Terminal No.	Relay
Common	⑦	C
EV1	⑧	NO
EV2	⑨	NO

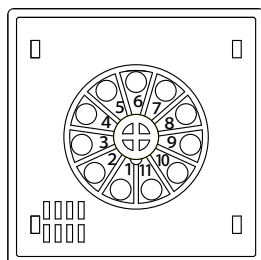

Name	Terminal No.	R T D	T C
Input	③	A	
	②	B	-
	①	b	+

Name	Terminal No.
Power Supply	⑩
	⑪

Terminal (6) is not used.

Terminal Descriptions

Relay Contact Output	C: Common, NO: Normal open
SSR Drive Voltage Output	Connect this directly to INPUT + and - on the SSR (Solid State Relay.)
EV1, 2	Possible to switch polarity between normal open and normal close.
Resistance Thermometer Output	Connect the A, B and b terminals carefully.
Thermocouple	Connect the + and - poles carefully.

Panel Installation Method

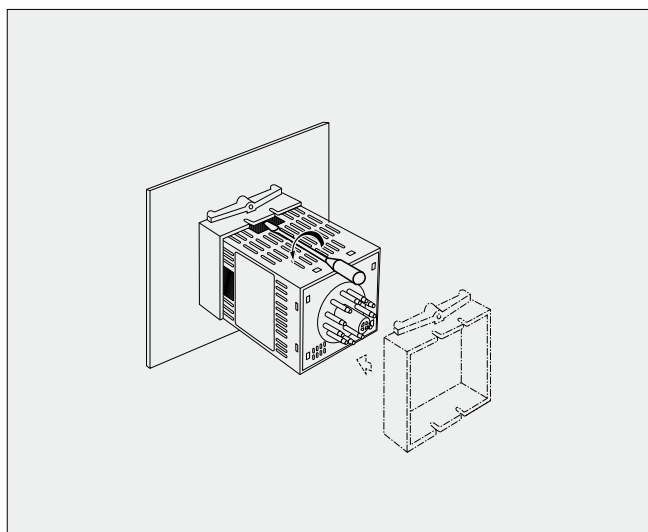

● A wiring connection socket is also available. Contact your nearest THD sales office for further details.

Panel Cross-Section and Dimensions

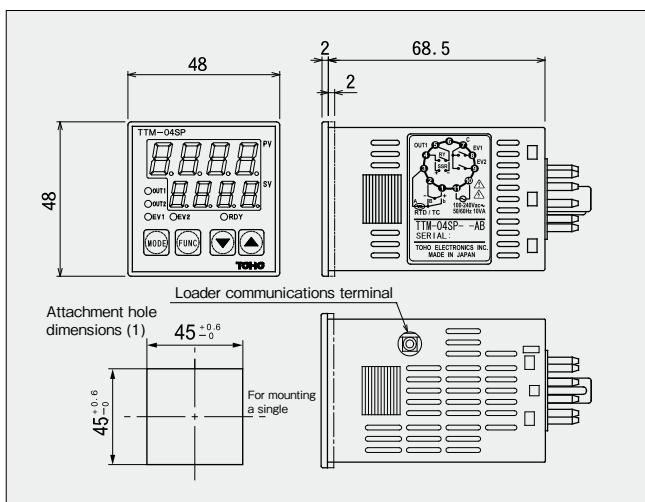

Function Descriptions

● Self-Tuning PID

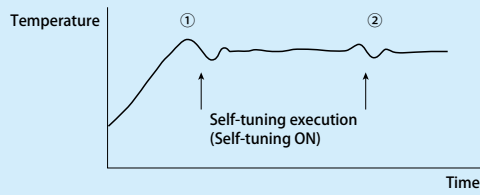

- (1) During parameter amendments
- (2) Temperature fluctuations during external disturbance and hunting

● Blind Function

● Mode Screen Blind Setup

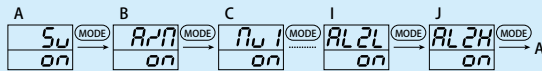

● Parameter Screen Blind Setup

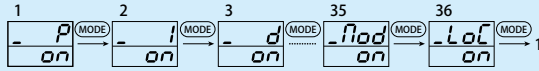

[ON] for display, [OFF] for non-display.

Key operations prevent any screen from being displayed.

Note that the accidental deletion of the SV parameter screen will result in only the measurement value (PV) being displayed without the set value during normal display.

● Timer Functions

1. Bread-Baking Oven

- Place the dough in the oven and then press the timer's start key.
 - The temperature is controlled by the heater, etc., when the timer is being set.
 - Control is automatically halted when the timer has finished counting.
- (To be used for halting control when the timer finishes counting.)

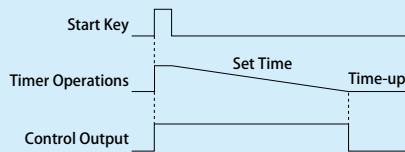

2. When control is started after peripheral equipment preparations are complete for packaged equipment and industrial equipment.

- The timer starts counting from the moment the power is switched on.
 - Control output is suspended while the timer is being set.
 - Control is automatically started when the timer finishes counting.
- (To be used for starting control when the timer finishes counting.)

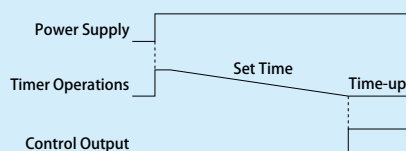

● Loader Communications Function

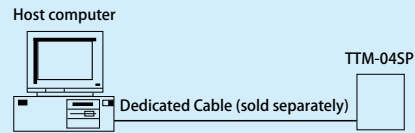

※ Loader Cable Specifications

[Appearance and Configuration]

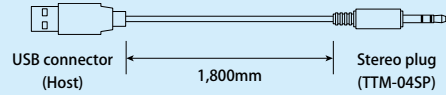

[Ratings and Performance]

USB I/F Rating	Conforming to USB Specifications 2.0
DTE (PC) Speed	Up to 19,200bps
Connector Specifications	PC: USB Thermometer: ϕ 2.5mm stereo plug

[Model]

TTM-LOADER

● Digital PV Filter

This function calculates a primary delay for the measurement value (PV) to create a CR filter effect with software. The filter effect can be set with the time constant (t).

(The time constant is the amount of time required for the PV value to reach approximately 63% when input fluctuates in steps.)

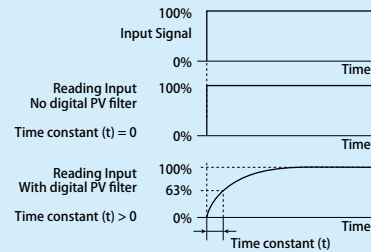

Uses for the Digital PV Filter

- 1) To eliminate high-frequency noise: The effects of noise are reduced when noise is added electronically to the input.
- 2) Possible to delay response for rapid input fluctuations.

● PID Overshoot Suppression Function

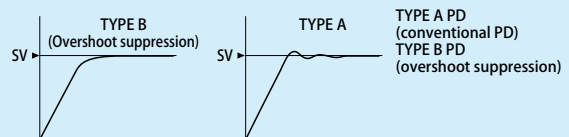

●Auto (RUN) / Manual Functions

It is possible to switch between automatic control and manual control with the key on the front panel.

Manual operations enable output control (operational volume) to be set and output at will, regardless of any deviations.

This allows the system to be operated manually to check operations of the terminals (valves and heaters, etc.) when testing system operations, and when normal control is not possible owing to malfunctioning sensors, etc.

The system is also equipped with balanceless and bumpless functions to suppress rapid fluctuations in control output when switching between automatic and manual operations, and to prevent damage to peripheral equipment and adverse effects on the control system caused by rapid fluctuations, which provides anxiety-free operations.

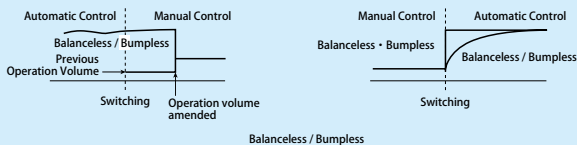

●Ramp Function

This is a function that waits for inclinations in SV (setting value) fluctuations. Actual operations consist of performing gradual fluctuations until the set value has been reached following amendment with a dummy set value in order to control the dummy set value.

The amount of fluctuation of the SV for a period of one minute is set. The ramp function is most effective in cases when fluctuations caused by the result of rapid control are not permissible owing to the characteristics of the subject being controlled, and when the fluctuation process (inclination) caused by the result of controlling the relevant subject is important.

Note that only the SV is fluctuated, and this may lead to situations in which the expected results of dramatic effects on the PV (measurement value) may not be achieved.

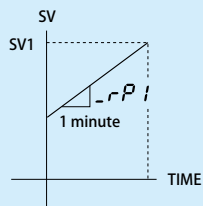

The set value from the temperature at start-up through to SV1 is fluctuated with the amount of fluctuation set in rP .

Start-up

* Possible operations when the SV2 option has been selected.

●ON/OFF Control's OFF Position Shift Function

The OFF position is the set value position when OFF position shift has been set at 0.

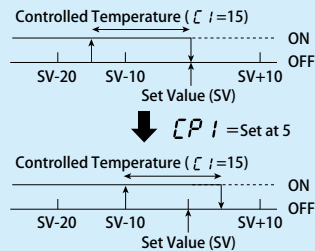

This example shows the OFF position shift set at [+5]. There are no fluctuations over the above example with the actual set value, so the shift is only carried out for the amount of [+5] as the ON/OFF position.

The shift is performed to the OFF position in the reverse of the above example when movement into the negative side is required.

●Heating/Cooling (supplied with the low-cost type)

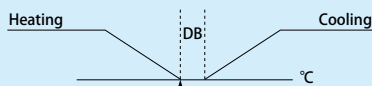

DB: Activates the proportional band and sensitivity for cooling.

Model Selection Chart

TTM-04SP--AB

Output1

Model	48×48mm		
Input	Thermocouple (K, J, R, T, N, S, B)		Can be switched with the multi-input key.
	Resistance Thermometer (Pt100, JPt100)		
Output 1	R	Relay Contact	
	P	SSR drive voltage	
Event Output	A	EV1	Contact output relay
	B	EV2	Contact output relay
			One must be selected
			Mounted as standard

1) [B] can be used as event output 2 or control output 2.



TOHO ELECTRONICS INC.

Head Office: 1-13-21, Tanashioda, Sagami-hara Kanagawa 229-1125 Japan.

Phone: +81-42-777-3311 FAX: +81-42-777-3751

E-Mail: overseas@toho-inc.co.jp

Web site: <http://www.toho-inc.co.jp>

● Specifications are subject to change without notice.

Note: The color printed in this catalog may be different from actual color.